

H2

Video Wall Splicer

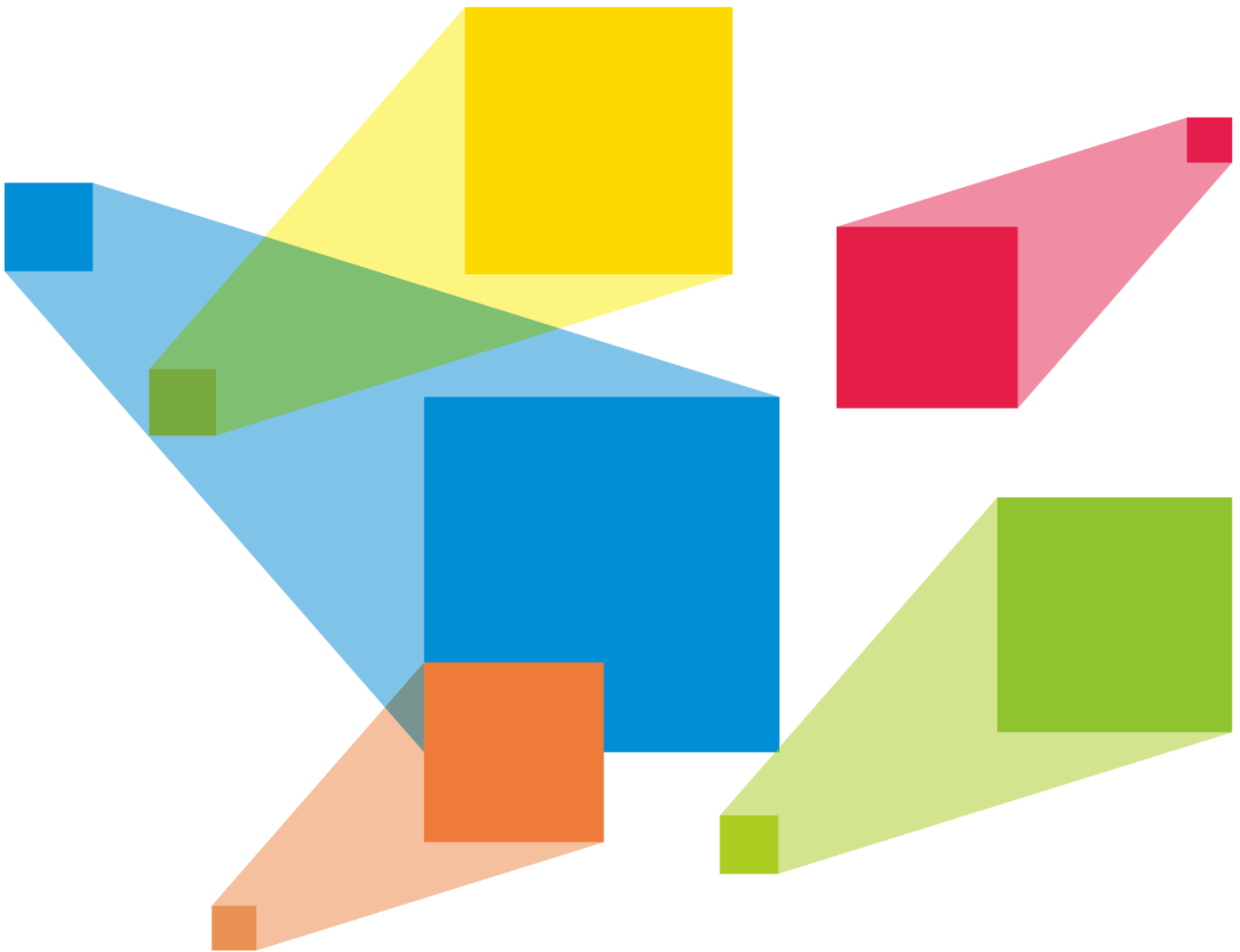

Specifications

Change History

| Document Version | Release Date | Description |
|------------------|--------------|---|
| V1.16.0 | 2025-12-15 | <p>Added the descriptions of the following cards:</p> <ul style="list-style-type: none"> • H_2xDP1.2 input card • H_4xfiber sending card (enhanced) |
| V1.15.0 | 2025-06-20 | <ul style="list-style-type: none"> • Added the descriptions of the following cards: <ul style="list-style-type: none"> – H_4xfiber input card – H_4xfiber input card-M – H_1xHDMI2.1+1xDP1.4 input card – H_4xfiber sending card-M • Deleted the descriptions of the following cards: <ul style="list-style-type: none"> – H_2xfiber input card-M – H_2xfiber input card |
| V1.14.0 | 2024-09-14 | <ul style="list-style-type: none"> • Added the descriptions of the following cards: <ul style="list-style-type: none"> – H_1xNDI input card – H_2xHDMI2.0+2xDP1.2 input card – H_2xHDMI2.0 input card |
| V1.13.0 | 2024-05-27 | Added the description of the H_1xST2110 input card. |
| V1.12.0 | 2024-01-31 | <ul style="list-style-type: none"> • Added the descriptions of the following cards: <ul style="list-style-type: none"> – H_1x12G SDI output card – H_2xfiber input card • Updated the specification of the H_2xRJ45 IP input card. • Updated the appearances of the following cards: <ul style="list-style-type: none"> – H_4xHDMI input card – H_1xDP1.2 input card – H_1xHDMI2.0+1xDP1.2 input card – H_1xHDMI2.0 input card – H_2xDP1.1 input card |

Introduction

The H2 is NovaStar's newest generation of video wall splicer, featuring excellent image quality and designed especially for fine-pitch LED screens. The H2 can work as splicing processors that integrate both video processing and video control capabilities, or work as pure splicing processors. The whole unit adopts a modular and plug-in design, and allows for flexible configuration and hot swapping of input and output cards. Thanks to excellent features and stable performance, the H2 can be widely used in a variety of applications, such as energy and power, water conservancy and hydrology, meteorologic earthquake prediction, enterprise management, metallurgy of steel, banking and finance, public security traffic management, exhibitions and presentations, production scheduling, radio and television, educational and scientific research, as well as stage rental applications.

Based on the powerful hardware FPGA system architecture, with a modular and plug-in design, the H2 features a stable and highly efficient pure hardware architecture, and provides a variety of connector modules for flexible and personalized configuration, allowing for easy maintenance and low failure rate. The H2 provides the industry-standard input connectors, including HDMI, DVI, DP, VGA, CVBS, SDI and IP, and supports 10-bit video source input and processing, as well as 4K high-definition inputs and outputs. The H2 also provides three kinds of LED 4K sending cards, allowing for the backup between the OPT ports and Ethernet ports as well as ultra-long distance transmission. Moreover, the H2 supports multi-screen and multi-layer management, input and output EDID management and monitoring, input source renaming, BKG and OSD settings and more, bringing you a rich image construction experience.

In addition, the H2 adopts the B/S architecture and supports cross-platform, cross-system access and control without the need to install an application program. On a Windows, Mac, iOS, Android or Linux platform, online collaboration of multiple users is supported and the Web page response speed is very fast, which greatly improves on-site setup efficiency. What's more, the H2 supports online firmware update, allowing for easy hardware update on a PC.

Certifications

CCC, CE, FCC, IC, RCM, UKCA, KC, CMIM, CB, UL, PSE

If the product does not have the relevant certifications required by the countries or regions where it is to be sold, please contact NovaStar to confirm or address the problem. Otherwise, the customer shall be responsible for the legal risks caused or NovaStar has the right to claim compensation.

Features

Modular and plug-in design, free combination at your will

- Four kinds of LED 4K sending cards
 - H_20xRJ45 sending card loads up to 13,000,000 pixels.
 - H_16xRJ45+2xfiber sending card loads up to 10,400,000 pixels and provides two OPT ports that copy the outputs on Ethernet ports.
 - H_4xfiber sending card loads up to 20,800,000 pixels and supports three working modes, including independent, copy and backup.
 - H_4xfiber sending card (enhanced) loads up to 26,000,000 pixels and supports two working modes, including copy and backup.
 - The fiber sending card cannot be used together with the H_20xRJ45 sending card or H_16xRJ45+2xfiber sending card to load the same screen.
- The H_4xfiber sending card (enhanced) cannot be used together with the H_4xfiber sending card to load the same screen.
- Multi-capacity input on a single card slot
 - 4x 2K×1K@60Hz
 - 2x 4K×1K@60Hz
 - 2x 4K×2K@60Hz
 - 1x 4K×2K@120Hz/8K×4K@30Hz
- Simple screen configuration using a single card and connector
- Online status monitoring of all input and output cards
- Hot-swappable input and output cards
- H_2xRJ45 IP input card supports up to 512 IP camera inputs and input mosaic.
- Auto decryption of HDCP-encrypted sources
- Decimal frame rates supported
- HDR10 and HLG processing

Multi-screen management for centralized control

- Each screen can have its own output resolution.
- Output mosaic
Adopts the frame synchronization technology, which ensures all the output connectors output the image synchronously, and the image is complete and played smoothly, without any stuck, frame loss, tearing or piecing.
- Irregular screen configuration
Supports irregular rectangle mosaic without any limitations.
- Input source grouping management
- Eye saver mode
Display the image in a warmer but less bright way to relieve eye strain.
- LCD bezel compensation
- Multi-screen management and operations
Centralized management of multiple screens, such as preset group management, freezing, FTB, screen locking and brightness adjustment
- Configure signal source playback and use the source playback group as a layer source.
- Unified control of preset groups, one-click loading for high efficiency and convenience
Save presets of multiple screen to one preset group, realizing synchronous switching across multiple screens. This facilitates centralized management with lag-free, and significantly improves the switching efficiency and stability.

Diverse display possibilities for flexible configuration

- Multi-layer display
A single card supports up to 16x 2K layers, 8x DL layers, 4x 4K layers or 2x 8K layers.
All layers support cross-connector output and the layer quantity is not reduced for cross-connector output.
- Various OSD options, suitable for diverse application scenarios
 - Multiple OSD types: Supports the static text OSD, dynamic text OSD, time OSD and weather OSD, meeting diverse information display requirements
 - Customizable dynamic OSD text: Customize the scrolling text content, scrolling direction, speed and font style.
 - Independent screen management: OSD content and parameters can be set individually for each screen, preventing display interference.
 - Adjustable OSD transparency: All OSD components support transparency adjustment, allowing for harmonious integration with the background image and avoiding obstruction of main view content.
- Up to 2,000 presets
Fade effect and seamless switching supported, less than 60ms preset switching duration
- Scheduled playback of preset playlist
- Set whether to add the presets to playlist, which is ideal for monitoring, exhibitions, presentations, and other applications.
- BKG settings
BKG images do not occupy the layer resources. Max width×height of a BKG image ≤ 64KK
- Channel logo management
Set a text or image logo for identifying the input source.
- Input source cropping and renaming after cropping
Crop any input source image and form a new input source after cropping.
- HDR and 10-bit video processing, allowing for a more exquisite and clear image
- Color adjustment
Output connector color and screen color adjustable, including the brightness, contrast, saturation, hue and Gamma
- XR scenario control
- 3D function
Work with NovaStar's 3D emitter - EMT200 to enjoy the 3D visual effect.
- Low latency
Reduce the latency from the input source to the receiving card to as low as 1 frame.

Web-page control, easy, friendly and convenient

- Web control
Real-time response and 1000M/100M self-adaptive network control, allowing for multi-user collaboration
- Monitoring of inputs and outputs on Web page
- Firmware update on Web page
- Ark Visualized Management and Control Platform app control on pad device

- LCD menu control
- Device control via central control server, OpenAPI and SNMP protocols.

Status monitoring for better stability and reliability

- Self-test for fault detection
 - Auto monitoring and alarms
 - Backup design
 - Backup between devices
 - Backup between input sources
 - Backup between LED 4K sending cards
- Supports hardware monitoring, such as fan rotation speed, module temperature and voltage, running status, and sends fault alarms if necessary.

Appearance

Front Panel



*The picture shown is for illustration purpose only. Actual product may vary due to product enhancement.

Notes:

- This product can only be placed horizontally. Do not mount vertically or upside-down.
- The product can be mounted in a standard 19-inch rack capable of withstanding at least four times the total weight of the mounted equipment. Four M5 screws should be used to fix the product.

| Name | Description |
|------------|--|
| LCD screen | Displays the device status and monitoring information. |

Rear Panel

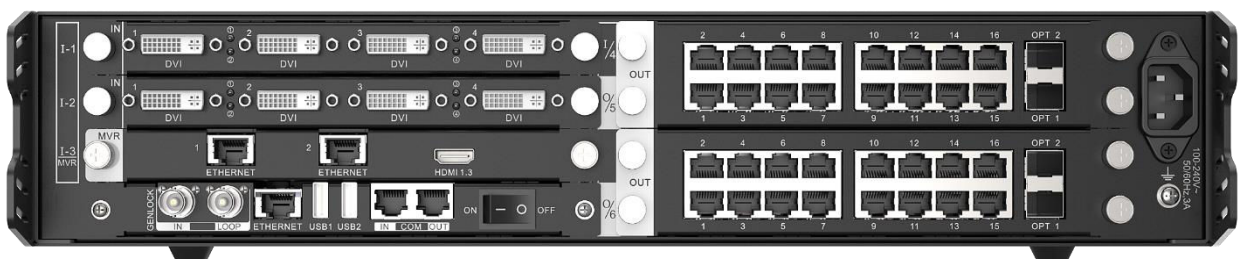

*The picture shown is for illustration purpose only. Actual product may vary due to product enhancement.

Notes:

- The silkscreen marking "I-x" or "I/x" indicates the slot is dedicated to the input card. "I" stands for input and "x" stands for the slot number. For example, "I-1" indicates this slot is the 1st input slot and for installing an input card only.
- The silkscreen marking "O-x" or "O/x" indicates the slot is dedicated to the output card. "O" stands for output and "x" stands for the slot number. For example, "O-10" indicates this slot is the 10th output slot and for installing an output card only.
- The silkscreen marking "I-x / MVR" indicates the slot can accept an input card or preview card.

| Available Input Cards | Available Output Cards |
|---|---|
| <ul style="list-style-type: none"> • H_1xHDMI2.1+1xDP1.4 input card • H_2xDP1.2 input card • H_1xHDMI2.0+1xDP1.2 input card • H_2xHDMI2.0+2xDP1.2 input card • H_1xDP1.2 input card • H_1xST2110 input card • H_1x12G SDI input card • H_2xHDMI2.0 input card • H_1xHDMI2.0 input card • H_4xfiber input card • H_2xDP1.1 input card • H_4xDVI input card • H_4xHDMI input card • H_2xRJ45 IP input card • H_4x3G SDI input card • H_2xCVBS+2xVGA input card • H_4xVGA input card • H_2xAudio input+2xAudio output card • H_4xHDBaseT input card • H_1xNDI input card • H_STD I/O card | <ul style="list-style-type: none"> • H_16xRJ45+2xfiber sending card • H_20xRJ45 sending card • H_4xfiber sending card • H_4xfiber sending card (enhanced) • H_1xHDMI2.0 output card • H_1x12G SDI output card • H_4xDVI output card • H_4xHDMI output card • H_4x3G SDI output card • H_4xHDBaseT output card |
| | Preview Card |
| | H_2xRJ45+1xHDMI1.3 preview card |
| | Control Card |
| | H_control card |
| | Power Module |
| | H_800W power |

Limitation On Use

- If the total layer quantity in the current preset or the preset to be switched exceeds 16x SL layers, 8x DL layers, 4x 4K layers or 2x 8K layers, the fade transition effect is not supported, while the cut transition is enabled by default.
- The layer capacity is matched with input connector capacity. If the specification of the connected input source is lower than the connector capacity, the latter shall prevail. You can change the connector capacity on the Device webpage.
For example, an input source with the resolution of 1080p is connected to an HDMI 2.0 connector, and use this connector to add a layer. The layer capacity is 4K instead of SL.
- Only the H_4xfiber input card supports input mosaic on a single card, while the mosaic source cannot be cropped.
- The backup relationship cannot be set for NDI or IPC sources.
- Instructions for the sending card with OPT ports
The optical module features a dual-core port. Each OPT port has both the TX (transmission) and RX (receiving) ends.
 - Normal TX, abnormal RX, normal display: The OPT port shown on the webpage is in gray.
 - Abnormal TX, normal RX, screen blackout: The OPT port shown on the webpage is in green.
 - Normal TX and RX, normal display: The OPT port shown on the webpage is in green.
- For the OpenAPI instructions of the H series, please copy and paste the link (<https://openapi.novastar.tech/en/h/>) into your browser.

Applications

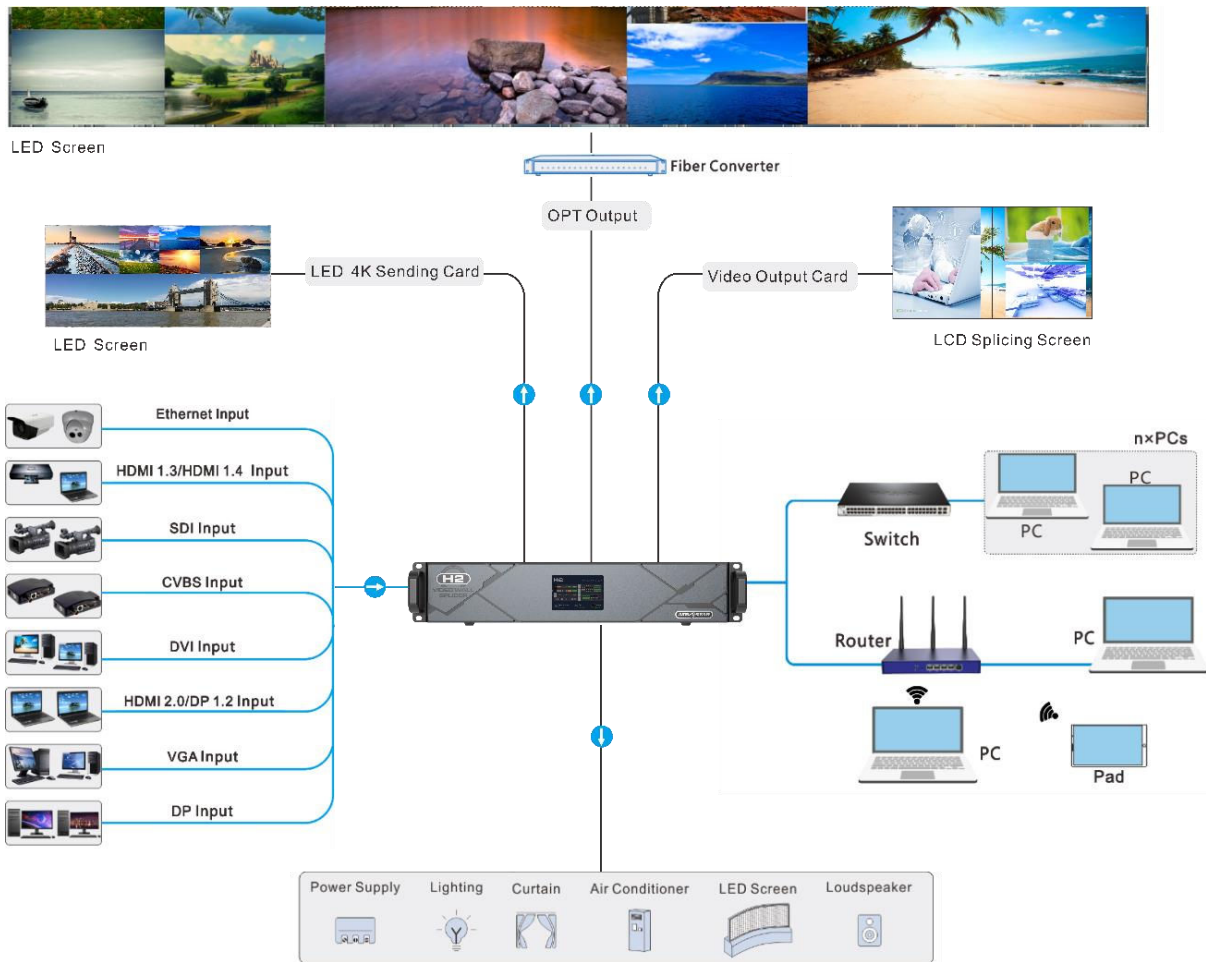

Dimensions

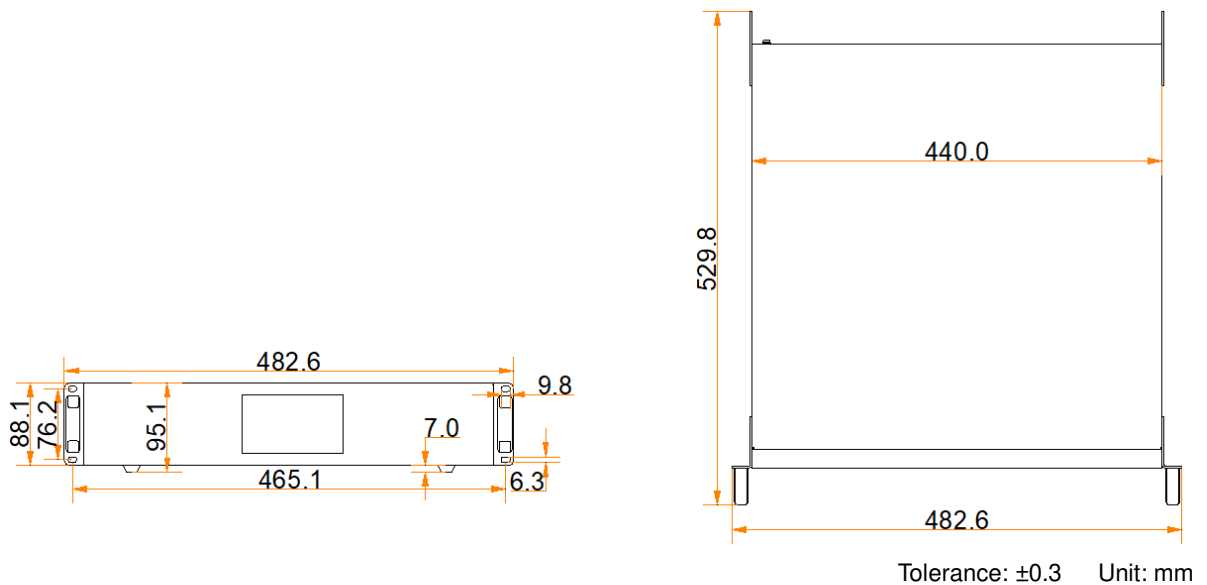

Specifications

| | | |
|---|--|--|
| Model | | H2 |
| Rack Unit | | 2U |
| Max. Input Cards | | 4 |
| Max. Input Channels | | 16 |
| Max. Output Cards | | 2 |
| Max. Output Channels | | 8 |
| Max. Loading Capacity | H_16xRJ45+2xfiber sending card | 20.8 million pixels |
| | H_20xRJ45 sending card | 26 million pixels |
| | H_4xfiber sending card | 41.6 million pixels |
| | H_4xfiber sending card (enhanced) | 52 million pixels |
| Max. Layers | | 32 |
| Electrical Specifications | Power connector | 100 to 240V~, 50/60Hz, 4.0A |
| | Power consumption | 210 W |
| Operating Environment | Temperature | 0°C to 45°C |
| | Humidity | 0% RH to 80% RH, non-condensing |
| Storage Environment | Temperature | -10°C to +60°C |
| | Humidity | 0% RH to 95% RH, non-condensing |
| Physical Specifications | Dimensions | 482.6 mm × 529.8 mm × 88.1 mm |
| | Net weight | 11 kg (chassis) |
| | Gross weight | 12.2 kg (chassis) |
| Noise Level (typical at 25°C /77°F) | | < 45 dB (A) |
| Packing Information | Packing box | 660 mm × 570 mm × 210 mm |
| | Accessories | 1x Power cord 1x RJ45 Ethernet cable 1x Grounding cable 1x HDMI cable |

| | | |
|--|--|--|
| | | 1x Quick Start Guide 1x Certificate of Approval 1x Safety Manual 1x Custom Letter |
|--|--|--|

Video Source Features

| Input Connector | Color Depth | | Max. Input Resolution |
|------------------------|-------------|-------------|-----------------------|
| ST 2110 (25G OPT port) | 8-bit | RGB 4:4:4 | 4096×2160@60Hz |
| | | YCbCr 4:4:4 | |
| | | YCbCr 4:2:2 | |
| | 10-bit | RGB 4:4:4 | |
| | | YCbCr 4:4:4 | |
| | | YCbCr 4:2:2 | |
| HDMI 2.1 | 8-bit | RGB 4:4:4 | 8192×4320@30Hz |
| | | YCbCr 4:4:4 | |
| | | YCbCr 4:2:2 | |
| | 10-bit | RGB 4:4:4 | |
| | | YCbCr 4:4:4 | |
| | | YCbCr 4:2:2 | |
| HDMI 2.0 | 8-bit | RGB 4:4:4 | 4096×2160@60Hz |
| | | YCbCr 4:4:4 | 8192×1080@60Hz |
| | | YCbCr 4:2:2 | |
| | 10-bit | RGB 4:4:4 | 4096×2160@30Hz |
| | | YCbCr 4:4:4 | 4096×1080@60Hz |
| | | YCbCr 4:2:2 | 4096×2160@60Hz |
| DP 1.4 | 8-bit | RGB 4:4:4 | 7680×4320@30Hz |
| | | YCbCr 4:4:4 | |
| | | YCbCr 4:2:2 | 8192×4320@30Hz |
| | 10-bit | RGB 4:4:4 | 7680×4320@24Hz |
| | | YCbCr 4:4:4 | |
| | | YCbCr 4:2:2 | 8192×4320@30Hz |
| DP 1.2 | 8-bit | RGB 4:4:4 | 4096×2160@60Hz |

| | | | |
|-------------|---|-------------|----------------|
| | | YCbCr 4:4:4 | 8192×1080@60Hz |
| | | YCbCr 4:2:2 | |
| | 10-bit | RGB 4:4:4 | 4096×2160@30Hz |
| | | YCbCr 4:4:4 | 4096×1080@60Hz |
| | | YCbCr 4:2:2 | 4096×2160@60Hz |
| | HDMI 1.4 DP 1.1 | 8-bit | RGB 4:4:4 |
| YCbCr 4:4:4 | | | |
| YCbCr 4:2:2 | | | |
| 10-bit | | RGB 4:4:4 | 2048×1152@60Hz |
| | | YCbCr 4:4:4 | |
| | | YCbCr 4:2:2 | 4096×1080@60Hz |
| HDMI 1.3 | 8-bit | RGB 4:4:4 | 2048×1152@60Hz |
| | | YCbCr 4:4:4 | |
| | | YCbCr 4:2:2 | |
| | 10-bit | RGB 4:4:4 | 2048×1152@60Hz |
| | | YCbCr 4:4:4 | |
| | | YCbCr 4:2:2 | |
| NDI | 8-bit | YCbCr 4:4:4 | 4096×2160@60Hz |
| | | YCbCr 4:4:0 | |
| SL-DVI | 8-bit | RGB 4:4:4 | 2048×1152@60Hz |
| DL-DVI | 8-bit | RGB 4:4:4 | 3840×1080@60Hz |
| VGA CVBS | - | RGB 4:4:4 | 1920×1080@60Hz |
| 3G-SDI | <ul style="list-style-type: none"> • Supports up to 1920×1080@60Hz video inputs. • Input resolution and bit depth settings are not allowed. • Supports ST-424 (3G) and ST-292 (HD). | | |
| 12G-SDI | <ul style="list-style-type: none"> • Supports up to 4096×2160@60Hz video inputs. • Input resolution and bit depth settings are not allowed. • Supports ST-2082-1 (12G), ST-2081-1 (6G), ST-424 (3G) and ST-292 (HD). | | |

Notes and Cautions

Notes For Battery

- The battery is not intended to be replaced.

- Disposal of a battery into fire or a hot oven, or mechanically crushing or cutting of a battery can result in an explosion.
- Leaving a battery in an extremely high temperature surrounding environment can result in an explosion or the leakage of flammable liquid or gas.
- A battery subjected to extremely low air pressure may result in an explosion or the leakage of flammable liquid or gas.

Notes for Installation

When the product needs to be installed on the rack, 8 screws at least M5*8 should be used to fix it. The rack for installation shall bear at least four times the total weight of the mounted equipment.

- A. Elevated Operating Ambient - If installed in a closed or multi-unit rack assembly, the operating ambient temperature of the rack environment may be greater than room ambient. Therefore, consideration should be given to installing the equipment in an environment compatible with the maximum ambient temperature (T_{ma}) specified by the manufacturer.
- B. Reduced Air Flow - Installation of the equipment in a rack should be such that the amount of air flow required for safe operation of the equipment is not compromised.
- C. Mechanical Loading - Mounting of the equipment in the rack should be such that a hazardous condition is not achieved due to uneven mechanical loading.
- D. Circuit Overloading - Consideration should be given to the connection of the equipment to the supply circuit and the effect that overloading of the circuits might have on overcurrent protection and supply wiring. Appropriate consideration of equipment nameplate ratings should be used when addressing this concern.
- E. Reliable Earthing - Reliable earthing of rack-mounted equipment should be maintained. Particular attention should be given to supply connections other than direct connections to the branch circuit (e.g. use of power strips).

FCC Caution

Any changes or modifications not expressly approved by the party responsible for compliance could void the user's authority to operate the equipment.

This device complies with part 15 of the FCC Rules. Operation is subject to the following two conditions: (1) This device may not cause harmful interference, and (2) this device must accept any interference received, including interference that may cause undesired operation.

Note: This equipment has been tested and found to comply with the limits for a Class A digital device, pursuant to part 15 of the FCC Rules. These limits are designed to provide reasonable protection against harmful interference when the equipment is operated in a commercial environment. This equipment generates, uses, and can radiate radio frequency energy and, if not installed and used in accordance with the instruction manual, may cause harmful interference to radio communications. Operation of this equipment in a residential area is likely to cause harmful interference in which case the user will be required to correct the interference at his own expense.

Others

- This is Class A product. In a domestic environment, this product may cause radio interference in which case the user may be required to take adequate measures.
- Please read the specifications thoroughly and use the product in accordance with the requirements. If you have any questions about the specifications, please contact us immediately. If you use the product improperly, not

following the requirements, or for illegal purposes, you shall be solely responsible for any consequences arising therefrom.

Input Cards

H_1xHDMI2.1+1xDP1.4 Input Card

Appearance



- Only one connector can be used each time.
- Set to use which connector on the Web page. The default option is DP 1.4 connector.
- Support for 144Hz input
- Support for connector capacity configuration, including SL, DL, 4K and 8K
- Does not support interlaced signal input.

1x HDMI 2.1

- Backward compatible with HDMI 2.0, HDMI 1.4 and HDMI 1.3
- Supports the maximum resolution of 8192×4320@30Hz and the minimum resolution of 800×600@59.94Hz.
- HDCP 2.3 compliant
- Supports embedded audio input, with audio sampling rate of 48kHz.
- Custom resolutions:
 - Max. width: 8192 pixels (8192×2304@60Hz)
 - Max. height: 8192 pixels (2188×8192@60Hz)

1x DP1.4

- Backward compatible with DP 1.2 and DP 1.1
- Supports the maximum resolution of 8192×4320@30Hz and the minimum resolution of 800×600@59.94Hz
- Supports embedded audio input, with audio sampling rate of 48kHz.
- HDCP 2.3 compliant
- Custom resolutions:
 - Max. width: 8192 pixels (8192×2304@60Hz)
 - Max. height: 8192 pixels (2188×8192@60Hz)

Status LEDs

- On: The input source is accessed normally.
- Off: No input source is accessed or the input source is abnormal.

Specifications

- Weight: 550 g
- Dimensions: 193 mm × 247.12 mm × 21.15 mm
- Power consumption: 17 W

Note:

To ensure stable transmission of 8K ultra HD images, it is recommended to use HDMI 2.1/DP 1.4 certified video cables.

H_2xDP1.2 Input Card

Appearance



2x DP 1.2

- Backward compatible with DP 1.1
- Supports the maximum resolution of 4096×2160@60Hz/8192×1080@60Hz and the minimum resolution of 800×600@59.94Hz.
- Custom resolutions:
 - Max. width: 8192 pixels (8192×1152@60Hz)
 - Max. height: 8188 pixels (1012×8188@60Hz)
- HDCP 2.2 compliant
- Supports embedded audio input.
- Support for 144Hz input
- Support for connector capacity configuration, including SL, DL and 4K.
- Does not support interlaced signal input.

Status LEDs

- On: The input source is accessed normally.
- Off: No input source is accessed or the input source is abnormal.

Specifications

- Weight: 550 g
- Dimensions: 193 mm × 247.12 mm × 21.15 mm
- Power consumption: 9.6 W

H_1xHDMI2.0+1xDP1.2 Input Card

Appearance

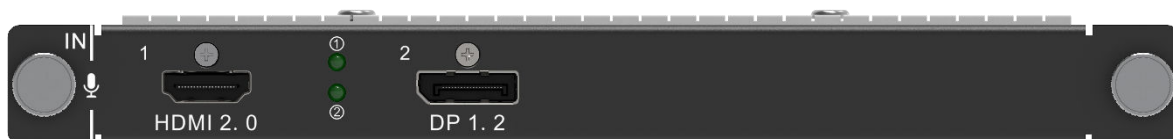

- **Only one connector can be used each time.**
- Set to use which connector on the Web page. The default option is HDMI 2.0 connector.
- Support for embedded audio and 144Hz input
- Does not support interlaced signal input.
- Support for connector capacity configuration, including SL, DL and 4K.

1x HDMI 2.0

- Backward compatible with HDMI 1.4 and HDMI 1.3
- Supports the maximum resolution of 4096×2160@60Hz and the minimum resolution of 800×600@59.94Hz.
- HDCP 2.2 compliant
- Custom resolutions:
 - Max. width: 8192 pixels (8192×1152@60Hz)
 - Max. height: 8188 pixels (1012×8188@60Hz)

1x DP 1.2

- Backward compatible with DP 1.1
- Supports the maximum resolution of 4096×2160@60Hz or 8192×1080@60Hz and the minimum resolution of 800×600@59.94Hz.
- HDCP 2.2 compliant
- Custom resolutions:
 - Max. width: 8192 pixels (8192×1152@60Hz)
 - Max. height: 8188 pixels (1012×8188@60Hz)

Status LEDs

- On: The input source is accessed normally.
- Off: No input source is accessed or the input source is abnormal.

Specifications

- Weight: 550 g
- Dimensions: 193 mm × 247.12 mm × 21.15 mm
- Power consumption: 9.6 W

H_2xHDMI2.0+2xDP1.2 Input Card

Appearance



- Two group inputs, each group with 1x HDMI 2.0 and 1x DP1.2 connector
- **Only one connector of each group can be used each time.**
- Set to use which connector on the Web page. The default option is HDMI 2.0 connector.
- Support for 144Hz input
- Support for connector capacity configuration, including SL, DL and 4K.
- Does not support interlaced signal input.

2x HDMI 2.0

- Backward compatible with HDMI 1.4 and HDMI 1.3
- Supports the maximum resolution of 4096×2160@60Hz and the minimum resolution of 800×600@59.94Hz.
- HDCP 2.2 compliant
- Supports embedded audio.
- Supports 144Hz input.
- Custom resolutions:
 - Max. width: 8192 pixels (8192×1152@60Hz)
 - Max. height: 8188 pixels (1012×8188@60Hz)

2x DP1.2

- Backward compatible with DP 1.1
- Supports the maximum resolution of 4096×2160@60Hz or 8192×1080@60Hz and the minimum resolution of 800×600@59.94Hz.
- HDCP 2.2 compliant
- Supports embedded audio.
- Supports 144Hz input.
- Custom resolutions:

- Max. width: 8192 pixels (8192×1152@60Hz)
- Max. height: 8188 pixels (1012×8188@60Hz)

Status LEDs

- On: The input source is accessed normally.
- Off: No input source is accessed or the input source is abnormal.

Specifications

- Weight: 550 g
- Dimensions: 193 mm × 247.12 mm × 21.15 mm
- Power consumption: 9.8 W

H_1xDP1.2 Input Card

Appearance



1x DP 1.2

- Backward compatible with DP 1.1
- Each connector supports the maximum resolution of 4096×2160@60Hz or 8192×1080@60Hz and the minimum resolution of 800×600@59.94Hz.
- Custom resolutions:
 - Max. width: 8192 pixels (8192×1152@60Hz)
 - Max. height: 8188 pixels (1012×8188@60Hz)
- HDCP 2.2 compliant.
- Supports embedded audio.
- Supports 144Hz input.
- Support for connector capacity configuration, including SL, DL and 4K.
- Does not support interlaced signal input.

Status LEDs

- On: The input source is accessed normally.
- Off: No input source is accessed or the input source is abnormal.

Specifications

- Weight: 550 g
- Dimensions: 193 mm × 247.12 mm × 21.15 mm
- Power consumption: 9.4 W

H_1xST2110 Input Card

Appearance

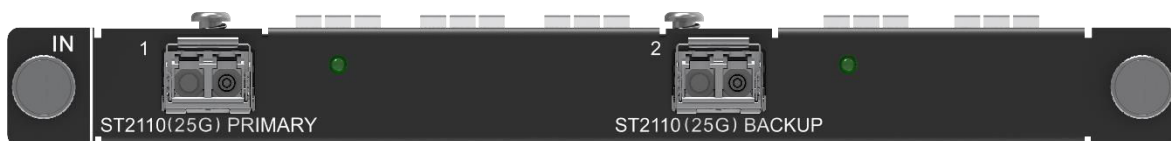

2x 25G OPT ports

- OPT 1 is used for primary input.
- OPT 2 serves as the backup of OPT 1.

- The primary input supports SMPTE ST 2110 (-10, 20) and SMPTE 2059 (-1, -2) standards.
- The backup input supports SMPTE 2022-7 standard.
- Supports VESA standard video inputs with up to 1x 4096x2160@60Hz input or 4x 2K inputs per card.
- Supports 8-bit/10-bit 4:4:4/4:2:2 inputs.
- Supports automatic identification of input source resolution and color space.
- Supports loading video stream configuration by SDP file or directly inputting.
- Supports BT.601/BT.709/BT.2020 inputs.
- Supports data transmission via 25 GbE IEEE 802.3cc (25GBASE-LR) and 25 GbE IEEE 802.3by (25GBASE-SR) standards.
- Supports IGMPv2 and IGMPv3 multicast protocols.
- Supports IPv4 dynamic addressing of the connector IP address and transmission of the static IP address.
- Input resolution settings are not allowed.
- Does not support interlaced signal inputs.

Status LEDs

- On: The corresponding port has a signal.
- Off: The corresponding port has no signal.

Specifications

- Weight: 500 g
- Dimensions: 193 mm × 247.12 mm × 21.15 mm
- Power consumption: 42 W

Notes:

- As it takes time for the connector to obtain the image, please do not repeatedly plug and unplug the connector in a short period of time.
- Two 25G optical modules are included with the card and are already installed into the OPT ports.

H_1x12G SDI Input Card

Appearance



1x 12G-SDI IN

- Backward compatible with 6G-SDI, 3G-SDI, HD-SDI and SD-SDI
- Supports ST-2082-1 (12G), ST-2081-1 (6G), ST-424 (3G), ST-292 (HD) and SMPTE 259 SD.
- Each connector supports the maximum resolution of 4096x2160@60Hz.
- Supports 1080i/576i/480i de-interlacing processing.
- Supports embedded audio input.
- Does not support input resolution and bit depth settings.

1x 12G-SDI LOOP

Loop out the 12G-SDI signal.

Status LEDs

- On: The input or loop output is connected normally.
- Off: No input or loop output is connected or the input or loop output is abnormal.

Specifications

- Weight: 550 g

- Dimensions: 193 mm × 247.12 mm × 21.15 mm
- Power consumption: 12 W

H_2xHDMI2.0 Input Card

Appearance



2x HDMI 2.0

- Backward compatible with HDMI 1.4 and HDMI 1.3
- Each connector supports the maximum resolution of 4096×2160@60Hz and the minimum resolution of 800×600@59.94Hz.
- Two 4K inputs can be connected at the same time.
- Support for connector capacity configuration, including SL, DL and 4K.
- HDCP 2.2 compliant.
- Supports embedded audio.
- Supports 144Hz input.
- Custom resolutions:
 - Max. width: 8192 pixels (8192×1152@60Hz)
 - Max. height: 8188 pixels (1012×8188@60Hz)
- Does not support interlaced signal input.

Status LEDs

- On: The input source is accessed normally.
- Off: No input source is accessed or the input source is abnormal.

Specifications

- Weight: 550 g
- Dimensions: 193 mm × 247.12 mm × 21.15 mm
- Power consumption: 9.6 W

H_1xHDMI2.0 Input Card

Appearance



1x HDMI 2.0

- Backward compatible with HDMI 1.4 and HDMI 1.3
- Each connector supports the maximum resolution of 4096×2160@60Hz and the minimum resolution of 800×600@59.94Hz.
- HDCP 2.2 compliant.
- Supports embedded audio.
- Supports 144Hz input.
- Support for connector capacity configuration, including SL, DL and 4K.
- Custom resolutions:
 - Max. width: 8192 pixels (8192×1152@60Hz)

- Max. height: 8188 pixels (1012×8188@60Hz)
- Does not support interlaced signal input.

Status LEDs

- On: The input source is accessed normally.
- Off: No input source is accessed or the input source is abnormal.

Specifications

- Weight: 550 g
- Dimensions: 193 mm × 247.12 mm × 21.15 mm
- Power consumption: 9.3 W

H_4xfiber Input Card

Appearance



Input Card Type

- H_4xfiber input card
Four 10G SFP+ LR single-mode optical modules are included with the card and are already installed into the OPT ports.
- H_4xfiber input card-M
Four 10G SFP+ SR multi-mode optical modules are included with the card and are already installed into the OPT ports.

4x 10G OPT ports

- Each connector supports the maximum resolution of 4096×2160@30Hz.
- Each connector supports up to 2x SL inputs or 1x DL input.
- Supports input mosaic.
- Supports two input modes: independent and mosaic modes.
- Supports automatic identification of input source resolution and color space.
- Supports 144Hz input.
- The optical module supports SFP+ encapsulation. The supported module specifications include the followings:
 - Multi-mode optical module: 10G SFP+ SR optical module
 - Single-mode optical module: 10G SFP+ LR optical module
- Input resolution settings are not allowed.
- In Independent mode, only two OPT ports (either OPT 1~2 or OPT 3~4) can be used for SL input.

Status LEDs

- On: The corresponding port has a signal.
- Off: The corresponding port has no signal.

Specifications

- Weight: 500 g
- Dimensions: 193 mm × 247.12 mm × 21.15 mm
- Power consumption: 42 W

H_2xDP1.1 Input Card

Appearance



2x DP1.1

- Each connector supports the maximum resolution of 3840×1080@60Hz or 3840×2160@30Hz and the minimum resolution of 800×600@59.94Hz.
- Custom resolutions:
 - Max. width: 3840 pixels (3840×1202@60Hz)
 - Max. height: 3840 pixels (1092×3840@60Hz)
- Supports 8-bit and 10-bit inputs.
- HDCP 1.3 compliant.
- Supports embedded audio.
- Supports 144Hz input.
- Support for connector capacity configuration, including SL, DL and 4K.
- Does not support interlaced signal input.

Status LEDs

- On: The input source is accessed normally.
- Off: No input source is accessed or the input source is abnormal.

Specifications

- Weight: 550 g
- Dimensions: 193 mm × 247.12 mm × 21.15 mm
- Power consumption: 11.5 W

H_4xDVI Input Card

Appearance



- Support for single link and dual link input modes, 10-bit input source and 144Hz input
- HDCP 1.4 compliant
- Does not support interlaced signal input.

Single Link Mode

- Four DVI connectors are all used for input.
- Each connector supports the maximum resolution of 2048×1152@60Hz and the minimum resolution of 800×600@59.94Hz.
- Custom resolutions:
 - Max. width: 2560 pixels (2560×983@60Hz)
 - Max. height: 2560 pixels (884×2560@60Hz)

Dual Link Mode

- Connectors 2 and 4 are used for input, and connectors 1 and 3 are unavailable.

- Each connector supports the maximum resolution of 3840×1080@60Hz and the minimum resolution of 800×600@59.94Hz.
- Custom resolutions:
 - Max. width: 4096 pixels (4096×1130@60Hz)
 - Max. height: 4096 pixels (1014×4096@60Hz)

Status LEDs

- On: The input source is accessed normally.
- Off: No input source is accessed or the input source is abnormal.

Specifications

- Weight: 550 g
- Dimensions: 193 mm × 247.12 mm × 21.15 mm
- Power consumption: 9.4 W

H_4xHDMI Input Card

Appearance

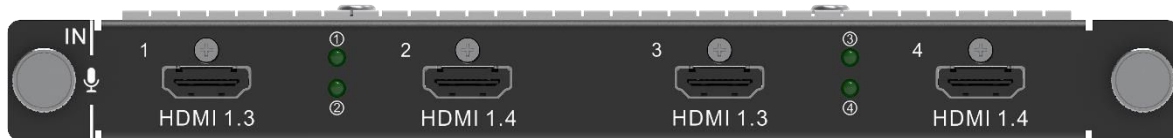

- Support for 10-bit input source, embedded audio and 144Hz input
- Does not support interlaced signal input.

HDMI 1.3 Inputs

- Four connectors are all used for input.
- Each connector supports the maximum resolution of 2048×1152@60Hz, and the minimum resolution of 800×600@59.94Hz.
- Custom resolutions:
 - Max. width: 2560 pixels (2560×983@60Hz)
 - Max. height: 2560 pixels (884×2560@60Hz)
- HDCP 1.4 compliant

HDMI 1.4 Inputs

- Two HDMI 1.4 connectors are used for input, but two HDMI 1.3 connectors are unavailable.
- Each connector supports the maximum resolution of 3840×1080@60Hz and the minimum resolution of 800×600@59.94Hz.
- Custom resolutions:
 - Max. width: 4096 pixels (4096×1130@60Hz)
 - Max. height: 4096 pixels (1014×4096@60Hz)
- HDCP 1.4 compliant

Status LEDs

- On: The input source is accessed normally.
- Off: No input source is accessed or the input source is abnormal.

Specifications

- Weight: 550 g
- Dimensions: 193 mm × 247.12 mm × 21.15 mm
- Power consumption: 9.3 W

H_2xRJ45 IP Input Card

Appearance



2x RJ45 Gigabit Ethernet Ports

- Supported protocols: RTSP, GB28181 and ONVIF
- Supported coding formats for IPC videos: H.264 and H.265
- Supports decoding of video streaming provided by the encoder.
 - Supports decoding of unicast video streaming.
 - Supports decoding of 8-bit H.264/H.265 YUV420 videos of I-frames and P-frames.
- Single card decoding capability:
 - 4x 4K×2K
 - 8x 4K×1K
 - 16x 2K×1K
 - 64x D1
- DHCP compliant

Specifications

- Weight: 550 g
- Dimensions: 193 mm × 247.12 mm × 21.15 mm
- Power consumption: 11.5 W

H_4x3G SDI Input Card

Appearance



4x 3G-SDI

- Backward compatible with HD-SDI and SD-SDI
- Supports ST-424 (3G), ST-292 (HD) and SMPTE 259 SD.
- Each connector supports the maximum resolution of 1920×1080@60Hz.
- Supports 1080i/576i/480i de-interlacing processing.
- Supports embedded audio input.
- Does not support input resolution and bit depth settings.

Status LEDs

- On: The input source is accessed normally.
- Off: No input source is accessed or the input source is abnormal.

Specifications

- Weight: 550 g
- Dimensions: 193 mm × 247.12 mm × 21.15 mm
- Power consumption: 12.6 W

H_2xCVBS+2xVGA Input Card

Appearance



- 2x VGA
 - Each connector supports the maximum resolution of 1920×1200@60Hz.
 - Does not support interlaced signal input.
- 2x CVBS
 - Supports PAL and NTSC.
 - Supports interlaced signal input.

Status LEDs

- On: The input source is accessed normally.
- Off: No input source is accessed or the input source is abnormal.

Specifications

- Weight: 550 g
- Dimensions: 193 mm × 247.12 mm × 21.15 mm
- Power consumption: 9.3 W

H_4xVGA Input Card

Appearance



- 4x VGA
 - Each connector supports the maximum resolution of 1920×1200@60Hz.
 - Does not support interlaced signal input.

Status LEDs

- On: The input source is accessed normally.
- Off: No input source is accessed or the input source is abnormal.

Specifications

- Weight: 550 g
- Dimensions: 193 mm × 247.12 mm × 21.15 mm
- Power consumption: 16.2 W

H_2xAudio Input+2xAudio Output Card

Appearance



- Single channel: 4x phoenix audio inputs, 4x phoenix audio outputs
- Dual channel: 2x phoenix audio inputs, 2x phoenix audio outputs

- Audio sampling rate: 48 kHz
- When the single channel balanced audio is used as the audio source, both the input and output audio channels are four.
- When the dual channel balanced audio is used as the audio source, both the input and output channels will be halved.
- Output the embedded audio of the video input connector and the audio of the audio input card.
- Output volume adjustment and one-click mute function supported
- Switching between the single channel and dual channel
- Audio output delay supported

Specifications

- Weight: 550 g
- Dimensions: 193 mm × 247.12 mm × 21.15 mm
- Power consumption: 6 W

Note:

If you want to output the embedded audio, please select the layer opened by the input card with the silkscreen marking  or the input card supporting embedded audio input.

H_4xHDBaseT Input Card

Appearance

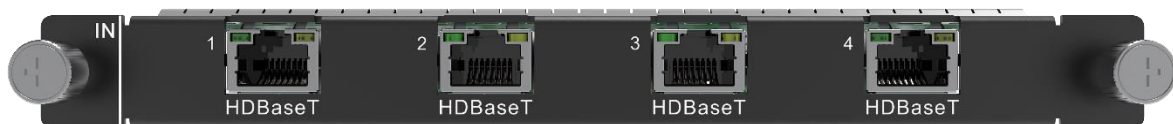

4x RJ45 Gigabit Ethernet ports

Support for single link and dual link input modes, and embedded audio

Single Link Input

- Four connectors are all available for input.
- Each connector supports the maximum resolution of 1920×1080@60Hz and the minimum resolution of 800×600@59.94Hz.
- Custom resolution:
 - Max. width: 2560 pixels (2560×983@60Hz)
 - Max. height: 2560 pixels (884×2560@60Hz)
- HDCP 1.4 compliant

Dual Link Input

- Connector 2 and 4 are available for input.
- Each connector supports the maximum resolution of 3840×2160@30Hz and the minimum resolution of 800×600@59.94Hz.
- Custom resolution:
 - Max. width: 4096 pixels (4096×1130@60Hz)
 - Max. height: 4096 pixels (1014×4096@60Hz)
- HDCP 1.4 compliant

Status LEDs

- Green: Indicating the input source access status

- On: The input source is accessed normally.
- Off: No input source is accessed.
- Yellow: Indicating the input source status
 - On: The input source is normal.
 - Off: The input source has no signal or the input source is abnormal.
 - Flashing: The connector is in communication.

Specifications

- Weight: 500 g
- Dimensions: 193 mm × 247.12 mm × 21.15 mm
- Power consumption: 39 W

H_1xNDI Input Card

Appearance



1x RJ45 Gigabit Ethernet Input

- Supports 8-bit YUV4:2:2 or YUV4:2:0 input decoding.
- Single card decoding capability:
 - 4x 2K×1K@60Hz
 - 2x 4K×1K@60Hz
 - 1x 4K×2K@60Hz
- DHCP supported
- Supports video decoding in Full NDI format.
- Does not support standard and custom resolution settings for the input source.

Status LEDs

- Green: Indicating the input source access status
 - On: The input source is accessed normally.
 - Off: No input source is accessed.
- Yellow: Indicating the input source status
 - On: The input source is normal.
 - Off: The input source has no signal or the input source is abnormal.
 - Flashing: The connector is in communication.

Specifications

- Weight: 500 g
- Dimensions: 193 mm × 247.12 mm × 21.15 mm
- Power consumption: 42 W

H_STD I/O Card

Appearance

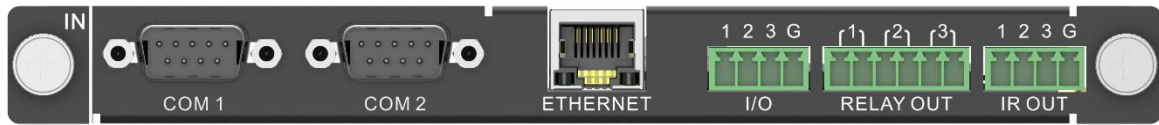

This card can be installed into the input card slots.

2x COM

Programmable RS422/RS485/RS232 ports that are used to control the devices that adopt RS422/RS485/RS232 protocol

- COM port pins are shown as below:

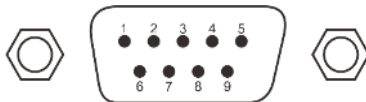

- Pin wirings are shown as below:

| PIN | 1 | 2 | 3 | 4 | 5 | 6 | 7 | 8 | 9 |
|--------|-----------|-------|-------|-----|------|-------|---|---|---|
| RS-232 | —RXD—TXD— | | —GND— | | | | | | |
| RS-422 | RXD- | —TXD+ | | GND | RXD+ | —TXD- | | | |
| RS-485 | —A— | | | | —B— | | | | |

1x ETHERNET

- Control the device connected to this card.
- 10/100Mbps self-adaptive, default IP address: 192.168.0.10
- TCP/IP protocol and UDP/IP protocol supported

3x I/O

- Trigger the execution of the function requirements via programming.
- Input and output modes supported
- Pins 1, 2 and 3 can be set to either the input or output, and pin G is the common grounding pin for pins 1, 2 and 3.

3x RELAY OUT

- Connect to the relay to control the power on and off the connected device.
- Forward voltage: 30V DC, forward current: 3A at maximum

Six pins are divided into three groups, which can be connected or disconnected via programming.

3x IR OUT

- Programmable infrared control supported
- Pins 1, 2 and 3 are used for infrared emission, and pin G is the common grounding pin for pins 1, 2 and 3.

Specifications

- Weight: 400 g
- Dimensions: 193 mm × 247.12 mm × 21.15 mm
- Power consumption: 1.2 W

Output Cards

H_16xRJ45+2xFiber Sending Card

Appearance

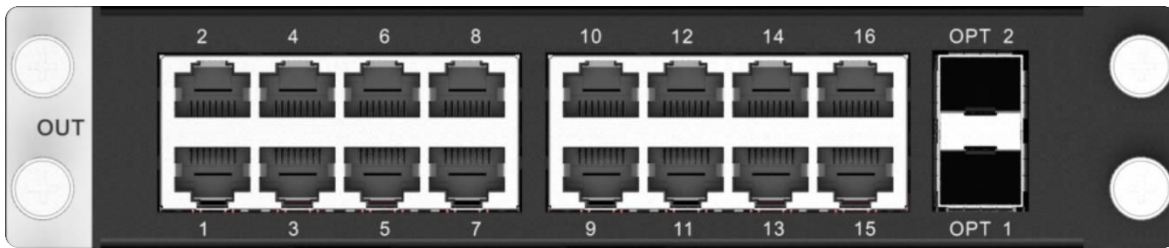

LED 4K sending card can load up to 10,400,000 pixels (max. width: 10,240 pixels, max. height: 10,240 pixels). This card occupies two slots.

16x RJ45 Gigabit Ethernet Outputs

- Bit depth: 8-bit
A single Ethernet port loads up to 650,000 pixels.
- Bit depth: 10-bit
A single Ethernet port loads up to 325,000 pixels.
- Backup between Ethernet ports
- Supports 144Hz output.

2x OPT Outputs

- Support both SMF and MMF transmission.
- OPT 1 copies and outputs the data on Ethernet ports 1–8.
- OPT 2 copies and outputs the data on Ethernet ports 9–16.
- Supports 144Hz output.

Specifications

- Weight: 600 g
- Dimensions: 193 mm × 247.12 mm × 41.25 mm
- Power consumption: 34.2 W

Notes:

- For the optical module connected to the OPT port, you need to order or purchase separately.
- It is recommended to connect a CVT series fiber converter to the OPT port.

H_20xRJ45 Sending Card

Appearance

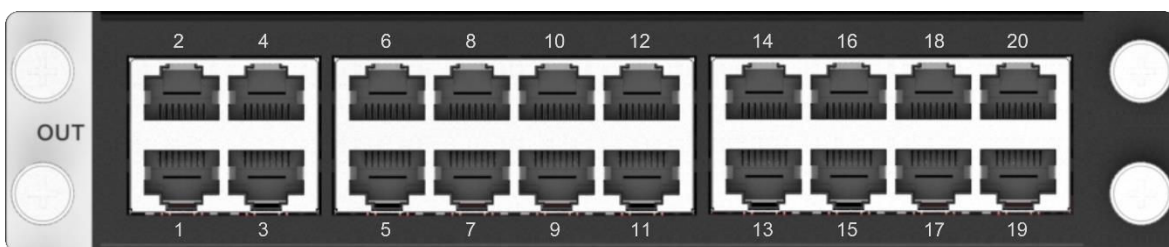

- LED 4K sending card can load up to 13,000,000 pixels (max. width: 10,752 pixels, max. height: 10,752 pixels).

- This card occupies two slots.

20x RJ45 Gigabit Ethernet Outputs

- Bit depth: 8-bit
A single Ethernet port loads up to 650,000 pixels.
- Bit depth: 10-bit
A single Ethernet port loads up to 325,000 pixels.
- Backup between Ethernet ports
- Supports 144Hz output.

Specifications

- Weight: 600 g
- Dimensions: 193 mm × 247.12 mm × 41.25 mm
- Power consumption: 40.1 W

H_4xFiber Sending Card

Appearance



4x 10G OPT Ports

This card can load up to 20,800,000 pixels (max. width: 16,384 pixels, max. height: 16,384 pixels)

- The loading capacity of one OPT port is equal to that of 8 Ethernet ports.
- Independent, copy and backup modes are supported.
- SM and MM optical modules are both supported, with a transmission distance of up to 10 km and 300 m respectively.
- Supports 8-bit and 10-bit outputs.
- Supports 144Hz output.
- The optical module supports SFP+ encapsulation. The supported module specifications include the followings:
 - Multi-mode optical module: 10G SFP+ SR optical module
 - Single-mode optical module: 10G SFP+ LR optical module
- The screen loaded by this card does not support the fade transition effect.

Independent

Four OPT ports are all used for output and have the same loading capacity. The loading capacity of one port is equal to that of 8 Ethernet ports.

Copy

OPT 1 and OPT 2 are used for main output. OPT 3 copies the output on OPT 1, while OPT 4 copies the output on OPT 2.

Backup

OPT 1 and OPT 2 are used for main output. OPT 3 serves as the backup of OPT 1, while OPT 4 serves as the backup of OPT 2.

Specifications

- Weight: 500 g
- Dimensions: 193 mm × 247.12 mm × 21.15 mm

- Power consumption: 39 W

Notes:

- For the H_4xfiber sending card, four 10G SFP+ LR optical modules are included with the card and are already installed into the OPT ports.
- For the H_4xfiber sending card-M, four 10G SFP+ SR optical modules are included with the card and are already installed into the OPT ports.
- When the screen is loaded by the H_4xfiber sending card, NovaLCT V5.4.8 or above is required for screen configurations.
- It is recommended to connect a CVT series fiber converter to the OPT port.

H_4xFiber Sending Card (Enhanced)

Appearance

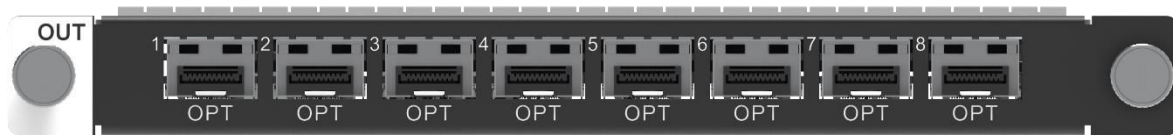

8x 10G OPT Ports

- OPT 1 to OPT 4 serve as the primary ports, and OPT 5 to OPT 8 serve as the backup ones.
 - OPT 5 backs up or copies the output on OPT 1.
 - OPT 6 backs up or copies the output on OPT 2.
 - OPT 7 backs up or copies the output on OPT 3.
 - OPT 8 backs up or copies the output on OPT 4.
- The loading capacity of one OPT port is equal to that of 10 Ethernet ports.
- Free topology supported.

Flexible screen configuration without rectangle restriction on a single Ethernet port. The total resolution of the large screen loaded by the device must be within the device loading capacity.
- Max loading capacity: 26,000,000 pixels (max. width: 16,384 pixels, max. height: 16,384 pixels)
- Copy and backup modes are supported. Only the cards set in the same modes can be used together to load a screen.
- Supports 8-bit and 10-bit outputs. The output bit depth needs to be set in NovaLCT.
- Supports 144Hz output.
- Both the single-mode and multiple-mode optical modules are supported, with the transmission distance of up to 10 km and 300 m respectively.
- The optical module supports SFP+ encapsulation. The supported module specifications include the followings:
 - Multi-mode optical module: 10G SFP+ SR optical module
 - Single-mode optical module: 10G SFP+ LR optical module
- This card cannot be used together with the H_4xfiber sending card, H_20xRJ45 sending card or H_16xRJ45+2xfiber sending card to load the same screen.
- The cards of the same type with the same frame rate but different resolutions can be used together to load a screen.
- The screen loaded by this card supports the fade transition effect.

Specifications

- Weight: 500 g
- Dimensions: 193 mm × 247.12 mm × 21.15 mm
- Power consumption: 36 W

Notes:

- For the H_4xfiber sending card (enhanced), four 10G SFP+ LR optical modules are included with the card and are already installed into the OPT 1 to OPT 4 ports.
- When the screen is loaded by the H_4xfiber sending card (enhanced), NovaLCT V5.4.8 or above is required for screen configurations.
- It is recommended to connect a CVT series fiber converter to the OPT port.
- For the receiving cards that support the free topology function, please contact out technical support staff to obtain related information.

H_4xDVI Output Card

Appearance



4x SL-DVI

Support for single output, dual link output and 144Hz output

Single Link Output

- Four connectors are all available for output.
- Each connector supports the maximum resolution of 2048×1152@60Hz.
- Custom resolutions:
 - Max. width: 2560 pixels (2560×972@60Hz)
 - Max. height: 2560 pixels (884×2560@60Hz)
- Supports 8-bit RGB 4:4:4/YCbCr 4:4:4/YCbCr 4:2:2 output.
- Supports 10-bit YCbCr 4:4:4 output.
- Supports output rotation by multiples of 90°.
 - In rotation mode, dual link output cannot be set and the layer quantity is halved with up to 8x SL layers supported.
 - In rotation mode, the loaded screen does not support the image OSD function.
 - In rotation mode, the loaded screen does not support the fade transition effect.
 - The cards supporting the rotation function cannot be used together with the cards of other types to load a screen. Even for the cards of the same type, the cards of the versions that support the rotation function and do not support this function cannot be used together to load a screen.
- Supports output image mirroring.

Dual Link Output

- Connectors 2 and 4 are available for output.
Connector 1 copies the output on connector 2, and connector 3 copies the output on connector 4.
- Adopts HDMI 1.4 protocol.
- Each connector supports the maximum resolution of 4096×2160@30Hz/3840×1080@60Hz.
- Custom resolutions:
 - Max. width: 4096 pixels (4096×1124@60Hz)
 - Max. height: 4096 pixels (1014×4096@60Hz)
- Supports 8-bit RGB 4:4:4/YCbCr 4:4:4/YCbCr 4:2:2 output.
- Supports 10-bit YCbCr 4:4:4 output.

Status LEDs

- On: The output connector is connected normally.
- Off: The output connector is not connected.

Specifications

- Weight: 500 g
- Dimensions: 193 mm × 247.12 mm × 21.15 mm
- Power consumption: 22.9 W

H_4xHDMI Output Card

Appearance

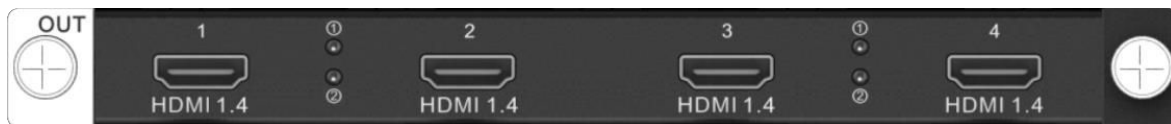

4x HDMI 1.4

Support for single output, dual link output and 144Hz output

Single Link Output

- Four connectors are all available for output.
- Each connector supports the maximum resolution of 2048×1152@60Hz.
- Custom resolutions
 - Max. width: 2560 pixels (2560×972@60Hz)
 - Max. height: 2560 pixels (884×2560@60Hz)
- Supports 8-bit RGB 4:4:4/YCbCr 4:4:4/YCbCr 4:2:2 output.
- Supports 10-bit RGB 4:4:4/YCbCr 4:4:4 output.
- Supports output rotation by multiples of 90°.
 - In rotation mode, dual link output cannot be set and the layer quantity is halved with up to 8x SL layers supported.
 - In rotation mode, the loaded screen does not support the image OSD function.
 - In rotation mode, the loaded screen does not support the fade transition effect.
 - The cards supporting the rotation function cannot be used together with the cards of other types to load a screen. Even for the cards of the same type, the cards of the versions that support the rotation function and do not support this function cannot be used together to load a screen.
- Supports output image mirroring.

Dual Link Output

- Connectors 2 and 4 are available for output.
Connector 1 copies the output on connector 2, and connector 3 copies the output on connector 4.
- Each connector supports the maximum resolution of 4096×2160@30Hz/3840×1080@60Hz.
- Custom resolutions
 - Max. width: 4096 pixels (4096×1124@60Hz)
 - Max. height: 4096 pixels (1014×4096@60Hz)
- Supports 8-bit RGB 4:4:4/YCbCr 4:4:4/YCbCr 4:2:2 output.
- Supports 10-bit RGB 4:4:4/YCbCr 4:4:4 output.

Status LEDs

- On: The output connector is connected normally.

- Off: The output connector is not connected.

Specifications

- Weight: 500 g
- Dimensions: 193 mm × 247.12 mm × 21.15 mm
- Power consumption: 22.1 W

H_1xHDMI2.0 Output Card

Appearance



2x HDMI 2.0

- Connector 2 copies the output on connector 1.
- The connector supports the maximum resolution of 8192×1080@60Hz/4096×2160@60Hz.
- Custom resolutions:
 - Max. width: 8192 pixels (8192×1146@60Hz)
 - Max. height: 8188 pixels (1012×8188@60Hz)
- Supports 8-bit or 10-bit RGB 4:4:4/YCbCr 4:4:4/YCbCr 4:2:2 output.
- Supports 144Hz output.

Status LEDs

- On: The output connector is connected normally.
- Off: The output connector is not connected.

Specifications

- Weight: 500 g
- Dimensions: 193 mm × 247.12 mm × 21.15 mm
- Power consumption: 21 W

H_4x3G SDI Output Card

Appearance

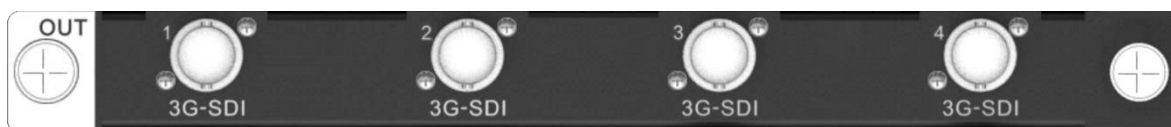

4x 3G-SDI

- Backward compatible with HD-SDI and SD-SDI output
- Each connector supports the maximum resolution of 1920×1080@60Hz.
- Supports 10-bit YCbCr 4:2:2 output.
- Supports Level A format only.
- The screen loaded by this card does not support the fade transition effect.
- Supports output rotation by multiples of 90°.
 - In rotation mode, dual link output cannot be set and the layer quantity is halved with up to 8x SL layers supported.
 - In rotation mode, the loaded screen does not support the image OSD function.

- In rotation mode, the loaded screen does not support the fade transition effect.
- The cards supporting the rotation function cannot be used together with the cards of other types to load a screen. Even for the cards of the same type, the cards of the versions that support the rotation function and do not support this function cannot be used together to load a screen.
- Supports output image mirroring.
- Supports the following standard output resolutions:
 - PAL: 720×576i@50Hz
 - NTSC: 720×480i@59.94Hz
 - 1920×1080i@50/59.94/60Hz
 - 1280×720p@23.98/24/25/29.97/30/50/59.94/60Hz
 - 1920×1080p@23.98/24/25/29.97/30/50/59.94/60Hz

Specifications

- Weight: 500 g
- Dimensions: 193 mm × 247.12 mm × 21.15 mm
- Power consumption: 24 W

H_4xHDBaseT Output Card

Appearance



4x RJ45 Gigabit Ethernet ports

Support for single link and dual link output modes

This card does not support the fade transition effect.

Supports the transmission distance up to 100m when Cat5e and Cat6 standard Ethernet cables are used.

Single Link Output

- Four connectors are all available for output.
- Each connector supports the maximum resolution of 2048×1152@60Hz.
- Custom resolution:
 - Max. width: 2560 pixels (2560×983@60Hz)
 - Max. height: 2560 pixels (884×2560@60Hz)
- Supports 8-bit RGB 4:4:4/YCbCr 4:4:4/YCbCr 4:2:2 output.
- Supports 10-bit RGB 4:4:4/YCbCr4:4:4 output.

Dual Link Output

- Connector 2 and 4 are available for output.
Connector 1 copies the output on connector 2, and connector 3 copies the output on connector 4.
- Each connector supports the maximum resolution of 4096×2160@30Hz/3840×1080@60Hz.
- Custom resolution:
 - Max. width: 4096 pixels (4096×1130@60Hz)
 - Max. height: 4096 pixels (1014×4096@60Hz)
- Supports 8-bit RGB 4:4:4/YCbCr 4:4:4/YCbCr 4:2:2 output.
- Supports 10-bit RGB 4:4:4/YCbCr4:4:4 output.

Status LEDs

- Green (on), yellow (flashing): The backend device is connected via the Ethernet cable.
- Green (off), yellow (off): The backend device or Ethernet cable is not connected.

Specifications

- Weight: 500 g
- Dimensions: 193 mm × 247.12 mm × 21.15 mm
- Power consumption: 32 W

H_1x12G SDI Output Card

Appearance



1x 12G-SDI and 1x 12G-SDI (COPY)

- The 12G-SDI connector is used for primary output, and the other one copies the output on the 12G-SDI.
- Backward compatible with 6G-SDI, 3G-SDI, HD-SDI and SD-SDI
- Supports ST-2082-1 (12G), ST-2081-1 (6G), ST-424 (3G), ST-292 (HD) and SMPTE 259 SD.
- Each connector supports the maximum resolution of 4096×2160@60Hz.
- Supports 10-bit YCbCr 4:2:2 output.
- Supports Level A format only.
- Custom output resolution settings are not allowed.
- The screen loaded by this card does not support the fade transition effect.

Specifications

- Weight: 500 g
- Dimensions: 193 mm × 247.12 mm × 21.15 mm
- Power consumption: 20 W

H_2xRJ45+1xHDMI1.3 Preview Card

Appearance



2x RJ45 Gigabit Ethernet Outputs

Connect to the network for monitoring the inputs and outputs.

1x HDMI 1.3

Connect to a monitor for displaying the monitoring information.

Specifications

- Weight: 500 g
- Dimensions: 193 mm × 247.12 mm × 21.15 mm
- Power consumption: 19.5 W

H_Control Card

Appearance



GENLOCK

Supports bi-level and tri-level.

- IN: Accept the Genlock signal.
- LOOP: Loop the Genlock signal.

ETHERNET

A Gigabit Ethernet port

- Connect to the control PC for communication.
- Connect to the router, switch or PC.
- For Web control and NovaLCT screen configuration

USB 1 & USB 2

2x USB 2.0

- Update the device program.
- Import or export the device configuration parameters.

Note:

The USB connectors cannot provide power for the connected devices.

COM

A serial port that adopts RS232 serial protocol

Support for central control system

The COM port uses an RJ45 port, and the wiring sequence follows the 568A standard.

- IN: Accept the commands from the central control system for the control of H series devices.
- OUT: Output the custom commands for the control of other devices.

Notes:

- The COM port cannot be connected to the network (router or switch) or LED cabinet (receiving card).
- The COM OUT port cannot be used for device cascading control.

Power Switch

- – / **ON**: Power on the device.
- **O** / **OFF**: Power off the device.

Specifications

- Weight: 500 g
- Dimensions: 193 mm × 247.12 mm × 21.15 mm
- Power consumption: 6.2 W

Copyright © 2025 Xi'an NovaStar Tech Co., Ltd. All Rights Reserved.

No part of this document may be copied, reproduced, extracted or transmitted in any form or by any means without the prior written consent of Xi'an NovaStar Tech Co., Ltd.

Trademark

 is a trademark of Xi'an NovaStar Tech Co., Ltd.

Statement

Thank you for choosing NovaStar's product. This document is intended to help you understand and use the product. For accuracy and reliability, NovaStar may make improvements and/or changes to this document at any time and without notice. If you experience any problems in use or have any suggestions, please contact us via the contact information given in this document. We will do our best to solve any issues, as well as evaluate and implement any suggestions.

| [Official website](http://www.novastar.tech)
| www.novastar.tech

| [Technical support](mailto:support@novastar.tech)
| support@novastar.tech