

VX2000 Pro

All-in-One Controller



Specifications

Change History

Document Version	Release Date	Description
V1.3.0	2026-02-11	<ul style="list-style-type: none"> Added the description for the function of device restoration. Added the description for the function of automatically enabling the low latency. HDMI 2.0, DP 1.2 and HDMI 1.3 support video inputs of 240 Hz at maximum. Added the description for the preset transition effect.
V1.2.0	2025-09-30	<ul style="list-style-type: none"> Added the description for the device standby mode. Added the description for the options of the monitoring image definition, including smooth and high-definition. Added the description for the dual receiving card backup. Added the description for screen power-on and power-off through a remote control. Added the description for the function of compatible with Mac. Added the description for the Unico client software.
V1.1.1	2025-08-15	<ul style="list-style-type: none"> Added the description for the HDR function. Added the description for the OSD function. Added the description for the remote control.
V1.0.3	2025-06-19	<ul style="list-style-type: none"> Added the description for the connector capacity limitations. Added the description for the flight case. Add new language options for the device LCD menu, including Hindi, Spanish, French, Portuguese, Russian, Japanese, Korean, German, Vietnamese, Turkish, Thai and Indonesian.
V1.0.2	2025-03-05	Optimized the content.
V1.0.1	2024-12-16	Update Unico-related information.
V1.0.0	2024-12-10	First release

Introduction

The VX2000 Pro is an all-in-one controller combining video processing and video control functionalities into a single device. Equipped with 20 Ethernet ports, it supports three working modes: video controller, fiber converter, and ByPass. Capable of managing up to 13 million

pixels, the VX2000 Pro can output at a maximum width of 16,384 pixels and a height of 8,192 pixels, making it perfectly suited for controlling ultra-wide and ultra-high LED screens on-site.

The VX2000 Pro boasts powerful video signal reception and processing capabilities, supporting a maximum resolution of 4K×2K@60Hz for video input. It can handle multiple video signal inputs and includes features like 12 layers, output scaling, low latency and pixel-level brightness and chroma calibration. These functions combine to deliver outstanding image display quality.

With various control options available, the VX2000 Pro can be operated via the front panel knob, NovaLCT, Unico and VICP app, providing you with a convenient and effortless control experience.

The VX2000 Pro is housed in an industrial-grade casing, which, combined with its powerful video processing and transmission capabilities, makes it robust and well-suited for complex operational environments. The VX2000 Pro is a perfect fit for medium and high-end rental, stage control systems and fine-pitch LED screens.

Certifications

CE, FCC, IC, PSE, RCM, EAC, UL, CB, KC, RoHS

If the product does not have the relevant certifications required by the countries or regions where it is to be sold, please contact NovaStar to confirm or address the problem.

Otherwise, the customer shall be responsible for the legal risks caused or NovaStar has the right to claim compensation.

Features

Multiple connectors, free input and output

- A comprehensive range of input connectors
 - 1x DP 1.2
 - 2x HDMI 2.0
 - 4x HDMI 1.3
 - 2x 10G optical fiber port (OPT 1 & OPT 2)
 - 1x 12G-SDI (IN & LOOP)
 - 1x USB 3.0 (Play images or videos saved in a USB drive.)

- Output connectors
 - 20x Gigabit Ethernet ports

A single device supports up to 13 million pixels, delivering a maximum width of 16,384 pixels and a maximum height of 8192 pixels.
 - 4x Fiber outputs

OPT 1 and OPT 2 send the output on Ethernet ports 1~10 and 11~20 respectively.

OPT 3 and OPT 4 copy or back up the output on Ethernet ports 1~10 and 11~20 respectively.
 - 1x HDMI output

For monitoring display. The monitoring image definition supports **Smooth** and **High-Definition**.
 - 1x 3D connector

Directly connect a third-party 3D emitter.
- Self-adaptive OPT 1/2 for either video input or sending card output

Thanks to the self-adaptive design, OPT 1/2 can be used as either an input or output connector, depending on its connected device.
- HDMI mosaic
 - Supports mosaicing of two HDMI 2.0 inputs or four HDMI 1.3 inputs.
 - Max. mosaicing resolution: 4K×2K
- Fiber input mosaic

The input source connected through OPT 1/2 can be used either independently or combined to create a mosaic input source.
- Audio input and output
 - Audio input accompanied with HDMI and DP sources
 - 3.5 mm independent audio input and output
 - Adjustable output volume
- Free topology

Flexible screen configuration without rectangle restriction on a single Ethernet port. The maximum circumscribed rectangle of the large screen loaded by the device must be within the device loading capacity.

*Specific receiving cards are required.
- Low latency

By enabling the low latency feature and ByPass mode, the device delay can be reduced to 0 frame.

- Output synchronization

An input source connected to the device's video connector or external Genlock source can be used as the sync source to ensure the output images of all cascaded units in sync.

- EDID management

Import and export EDID files.

Diverse display possibilities for flexible configuration

- Easy preset saving and loading

- Up to 256 user-defined presets supported
- Load a preset by simply pressing one button.
- Save, overwrite and delete a preset.
- Preview the layer layout saved in the preset.
- Set the preset switching effect.

- Multiple layer display

- Supports 12*2K×1K layer resources.

Users can create layers in three different specifications - 4K×2K, 4K×1K, and 2K×1K. These layers will use 4x, 2x, and 1x 2K layer resources respectively, depending on the capacity of the input source connector used to open the layers.

- Adjustable layer size and position
- Adjustable layer priority
- Adjustable aspect ratio

- OSD function

- Supports the text OSD and image OSD. For the text OSD, four components are available, including static text OSD, dynamic text OSD, weather OSD and time OSD.
- Supports customization of the text content, font, font color, size, opacity and background color.
- Supports configuration of the scrolling direction, initial position and speed for the dynamic text OSD.

- 3D function
 - Traditional solution: Connect the EMT200 Pro 3D emitter to the device's Ethernet port, and use the compatible 3D glasses to enjoy a 3D visual experience.
 - New solution: Connect the third-party 3D emitter to the device 3D connector and use the compatible 3D glasses to enjoy a 3D visual experience.

Note: When the 3D function is enabled and the video source format is **Side-by-Side** or **Top-and-Bottom**, the device output capacity will be halved.

- HDR output

Work with the receiving cards that support HDR to greatly enhance the image quality of the display, presenting more vivid and detailed images.

- HDR10 supported
- HLG supported

- Personalized image scaling

Supports three kinds of image scaling modes, including full screen, pixel to pixel and custom.

- Powerful video processing

- Based on SuperView III image quality processing technologies to provide stepless output scaling.
- One-click full screen display
- Free input cropping

- Color adjustment

Supports output color management, including brightness, saturation, contrast and hue.

- Pixel level brightness and chroma calibration

Work with NovaLCT and NovaStar calibration software to support brightness and chroma calibration on each LED, which can effectively remove color discrepancies and greatly improve LED display brightness and chroma consistency, allowing for better image quality. The function of displaying image on screen for test is also supported.

USB playback, timesaving and effortless

- Supports USB playback for instant plug-and-play convenience.

Multiple device modes and operation modes, convenient and efficient

- Various working modes

- Video controller
- Fiber converter
- ByPass
- Multiple control options
 - Device front panel knob
 - Unico

Both client software and web page control are supported.

- NovaLCT
- VICP app
- Remote control (optional)

Enable or disable the device standby mode, power on or power off the screen, adjust the screen brightness and output volume, switch presets, set the USB playback parameters, adjust the output image quality, switch layer input sources and set the 3D function through a remote control.

*For the descriptions of the remote control buttons and functions, please refer to the user manual.

Data saving after power failure and backup design, stable and reliable

- End-to-end backup
 - Backup between devices
 - Backup between input sources
 - Backup between Ethernet ports
 - Backup up between OPT and Ethernet ports
 - Dual receiving card backup

- Device restoration

Up to 5 restore points can be created (total capacity limit: 1GB). Each restore point is a snapshot of the device configuration at a specific moment. If something unexpected occurs, simply select a restore point to quickly revert the device configuration to the state it was in at the time the restore point was created.

- Ethernet port backup test

Test whether the pre-stored images, backup Ethernet ports and devices take effect without plugging and unplugging the Ethernet cables.

- Data saving after power failure

After a normal shutdown or unexpected power outage, reconnecting the power will automatically restore the previously saved settings on the device.

- 24/7 rigorous stability test under extreme high and low temperatures proved robust stability and reliability.

Table 4-1 Function limitations

Function	Limitation	Mutually Exclusive Function
3D	<ul style="list-style-type: none"> • Work with the matched 3D glasses. • When the 3D function is enabled and the video source format is Side-by-Side or Top-and-Bottom, the device output capacity will be halved. • When the 3D function is enabled and the video source format is Frame Sequential, you need to manually set the output frame rate which must be the same as the input frame rate. 	<ul style="list-style-type: none"> • Input crop • HDR
Low Latency	If you set the low latency mode to Auto , the system will determine whether to enable the low latency based on the screen topology. For specific rules, please refer to the user manual.	Genlock: When the device works as a video controller, the low latency and Genlock are not exclusive. When the device works in ByPass mode, the two functions cannot be enabled simultaneously.
GENLOCK	N/A	Low latency: When the device works as a video controller, the low latency and Genlock are not exclusive. When the device works in ByPass mode, the two functions cannot be enabled simultaneously.
ByPass Mode	When the device works as an independent LED display controller, the video processing function is unavailable.	N/A
HDR	Use the layer 1 source as an HDR source.	3D
OSD	<ul style="list-style-type: none"> • The quantity of the text OSD components is as follows. <ul style="list-style-type: none"> – Static text OSD: 10 – Dynamic text OSD: 1 – Weather OSD: 2 	Remote control: During remote control operation, all opened OSDs will be hidden and will appear once the operation is done.

Function	Limitation	Mutually Exclusive Function
	<ul style="list-style-type: none"> - Time OSD: 2 • The text OSD and image OSD cannot be used together. • The dynamic text OSD and other text OSD components cannot be used together. 	

Table 4-2 Latency at the VX2000 Pro

Working Mode	Low Latency (Unit: Frame)	Non-Low Latency (Unit: Frame)
Video controller	1~2	2~3
ByPass	0	1
Fiber converter	0	

Appearance

Front Panel



*The picture shown is for illustration purpose only. Actual product may vary due to product enhancement.

No.	Area	Function
1	Input source buttons	<ul style="list-style-type: none"> • Show the input source status and switch the layer input source. • Button indicators are used to indicate the working status of the input source signal. <ul style="list-style-type: none"> - On (blue): The input source has a signal. - Flashing (blue): The input source has no signals, but it is used by a layer. - On (white): The input source is not used, and no input signal is

No.	Area	Function
		<p>accessed.</p> <ul style="list-style-type: none"> • U-DISK: USB source button Press the button to switch to a USB source, while hold down the button to enter the Input Settings screen. • MEDIA: USB player button Press the button to enter the USB Player screen. <p> Note</p> <p>On the home screen, when layer 1 is opened, you can press the input source button to quickly switch the input source for layer 1.</p>
2	LCD screen	Display the device status, menus, submenus and messages.
3	Knob	<ul style="list-style-type: none"> • Rotate the knob to select a menu item or adjust the parameter value. • Press the knob to confirm the setting or operation.
4	Back button	Exit the current menu or cancel the operation.
5	Layer buttons	<p>Layer button description:</p> <ul style="list-style-type: none"> • LAYER 1~3: Open or close a layer, and show the layer status. <ul style="list-style-type: none"> – On (blue): The layer is opened. – Flashing (blue): The layer is being edited. – On (white): The layer is closed. • When you play media files saved in a USB drive, the layer buttons are used to control the playback. <ul style="list-style-type: none"> – LAYER-1: This button is used to play or pause the files. – LAYER-2: This button is used to stop the playback. – LAYER-3: This button is used to play the previous file. • SCALE: A shortcut button for the full screen function. Press the button to make the layer of the lowest priority fill the entire screen. <ul style="list-style-type: none"> – On (blue): Full screen scaling is turned on. – On (white): Full screen scaling is turned off. • When you play media files saved in a USB drive, this button is used to play the next file.
6	Function buttons	<ul style="list-style-type: none"> • PRESET: Access the preset settings menu. • TEST: Access the test pattern menu. • FREEZE: Freeze/unfreeze the output image. • FN: A custom function button
7	USB	Connect to the PC installed with NovaLCT for device control.

No.	Area	Function
8	U-DISK	<p>1x USB 3.0</p> <ul style="list-style-type: none"> • Supports USB playback. <ul style="list-style-type: none"> – Single-partition USB drive supported – File system: NTFS, FAT32 and exFAT – Max. width and height of media files Width: 3840 pixels, height: 2160 pixels – Picture format: jpg, jpeg, png and bmp – Decoded image resolution: 3840×2160 or lower – Video format: mp4, mkv, mov, avi, flv, m4v, mpg, mpeg, ts – Video coding: H.264, H.265, MPEG-2, MPEG-4 – Max. video frame rate: H.264: 3840×2160@30fps, H.265: 3840×2160@60fps MPEG-2/MPEG-4: 1920×1080@60fps – Max bitrate: H.264/H.265: 100Mbps MPEG-2/MPEG-4: 50Mbps – Audio coding: AAC, AC3, DTS, MP3, DVD, DVD_LPCM, MP2, OPUS – Audio sampling rate: opus: 24kHz, 48kHz Other formats: 22.05kHz to 94kHz – Transition effect of image switching: Ripple, zoom in, cut out, flip, blinds, H wipe, V wipe, cube, dissolve, grid, swapping, scroll, fade in/out, swirl, heart trans, doorway, perspective triangle, disappear, bounce, pinwheel, random <p> Note</p> <p>The resolution of a USB source is fixed at 3840×2160@60Hz.</p>

 **Note**

Hold down the knob and **BACK** button simultaneously for 3s or longer to lock or unlock the front panel buttons.

Rear Panel

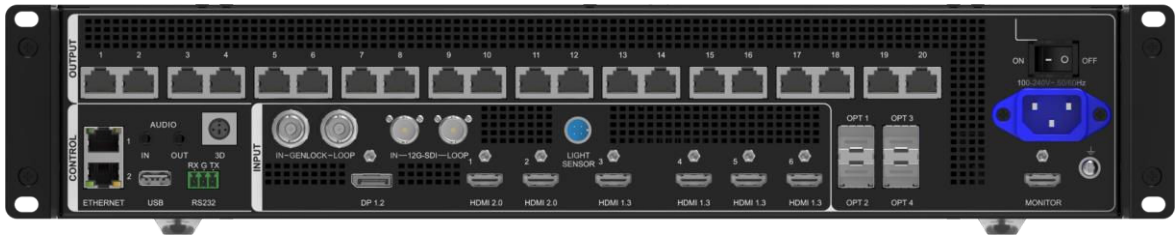



*The picture shown is for illustration purpose only. Actual product may vary due to product enhancement.

Connector	Qty	Description
Input Connectors		
DP 1.2	1	1x DP 1.2 <ul style="list-style-type: none"> • Max. input resolution: 4096×2160@60Hz • Supported frame rate: 23.98/24/25/29.97/30/47.95/48/50/56/59.94/60/70/71.93/72/75/85/100/119.88/120/144/240 • Custom resolutions supported <ul style="list-style-type: none"> – Max. width: 8192 pixels (8192×1080@60Hz) – Max. height: 8188 pixels (1080×8188@60Hz) • Supports 8-bit/10-bit/12-bit video inputs. • Supported color space/sampling rate: RGB 4:4:4/YCbCr 4:4:4/YCbCr 4:2:2 • HDCP 1.3 supported • Accompanied audio supported • Does not support interlaced signal inputs.
HDMI 2.0	2	2x HDMI 2.0 <ul style="list-style-type: none"> • Max. input resolution: 4096×2160@60Hz • Supported frame rate: 23.98/24/25/29.97/30/47.95/48/50/56/59.94/60/70/71.93/72/75/85/100/119.88/120/144/240 • Compatible with HDMI 1.4 and HDMI 1.3 video inputs • Custom resolutions supported <ul style="list-style-type: none"> – Max. width: 8192 pixels (8192×1080@60Hz) – Max. height: 8188 pixels (1080×8188@60Hz) • Supports 8-bit/10-bit/12-bit video inputs. • Supported color space/sampling rate: RGB 4:4:4/YCbCr 4:4:4/YCbCr

Connector	Qty	Description
		4:2:2/YCbCr 4:2:0. <ul style="list-style-type: none"> • HDCP 1.4 and HDCP 2.2 supported • Accompanied audio supported • Does not support interlaced signal inputs.
HDMI 1.3	4	4x HDMI 1.3 <ul style="list-style-type: none"> • Max. input resolution: 1920×1080@60Hz • Supported frame rate: 23.98/24/25/29.97/30/47.95/48/50/56/59.94/60/70/71.93/72/75/85/100/119.88/120/144/240 • Custom resolutions supported <ul style="list-style-type: none"> – Max. width: 2048 pixels (2048×1080@60Hz) – Max. height: 2048 pixels (1080×2048@60Hz) • Supports 8-bit video inputs. • HDCP 1.4 supported • Supported color space/sampling rate: RGB 4:4:4/YCbCr 4:4:4/YCbCr 4:2:2 • Accompanied audio supported • Does not support interlaced signal inputs.
12G-SDI	1	1x 12G-SDI <ul style="list-style-type: none"> • ST-2082 (12G), ST-2081 (6G), ST-424 (3G), ST-292 (HD) and ST-259 (SD) standard video inputs supported • Max. input resolution: 4096×2160@60Hz • 12G-SDI loop output supported • Deinterlacing processing supported • Does not support input resolution and bit depth settings.
*Connector capacity limitations		<ul style="list-style-type: none"> • SL <ul style="list-style-type: none"> – Standard resolution: 1920×1080@60Hz – Custom max width: 2048 (2048×1080@60Hz) – Custom max height: 2048 (1080×2048@60Hz) • DL <ul style="list-style-type: none"> – Standard resolution: 3840×1080@60Hz/3840×2160@30Hz – Custom max width: 4096 (4096×1080@60Hz) – Custom max height: 3840 (1080×3840@60Hz) • 4K <ul style="list-style-type: none"> – Standard resolution: 4096×2160@60Hz/8192×2160@30Hz – Custom max width: 8192 (8192×1080@60Hz)

Connector	Qty	Description
		<ul style="list-style-type: none"> - Custom max height: 8188 (1080×8188@60Hz) <div style="background-color: #f0f0f0; padding: 5px; margin-top: 5px;">  Note </div> <p>If the resolution of an input source is larger than the max width limit of the connector capacity, you need to switch the connector capacity to ensure that the input source can be processed normally.</p>
Output Connectors		
Ethernet ports	20	<ul style="list-style-type: none"> • 20x Gigabit Ethernet ports, max device loading capacity: 13 million pixels • Max. width: 16,384 pixels, max. height: 8192 pixels • Maximum capacity of a single port: <ul style="list-style-type: none"> - 8bit: 650,000 pixels - 10bit: Paired with receiving cards of different models, the loading capacity reduction in 10-bit color depth varies (325,000 pixels or 480,000 pixels). For detailed information, please contact our technical support. • Supported frame rate: <p style="margin-left: 20px;">23.98/24/25/29.97/30/47/48/50/59.94/60/71.93/72/75/85/95/100/119.88/120/144/240</p>
OPT	4	<p>4x 10G optical fiber ports</p> <p>*The physical line rate of the optical port is 10.3125 Gb/s, with an effective data throughput of 10 Gb/s.</p> <ul style="list-style-type: none"> • The function of the optical fiber port is different depending on the device working mode. <ul style="list-style-type: none"> - OPT 1/2: Self-adaptive, either for video input or for output - OPT 3/4: For output <p style="margin-left: 20px;">OPT 3 sends the output on Ethernet ports 1~10.</p> <p style="margin-left: 20px;">OPT 4 sends the output on Ethernet ports 11~20.</p> • Supports the following three modes: <ul style="list-style-type: none"> - Input+output: OPT 1/2 for video input, while OPT 3/4 copies or backs up the output on Ethernet ports - Input+loop+output: OPT 1 for video input, OPT 2 for loop output, while OPT 3/4 copies or backs up the output on Ethernet ports - Output: OPT 1/2 sends the output on Ethernet ports, while OPT 3/4 copies or backs up the output on Ethernet ports. • Paired with single-mode and dual-mode optical modules with the following transmission distance <ul style="list-style-type: none"> - Single-mode twin-core optical module: ≤10 km

Connector	Qty	Description
		<ul style="list-style-type: none"> Multi-mode twin-core optical module: ≤300 m <p> Note</p> <p>The optical module is not installed at the factory. Please purchase and install it as needed.</p>
HDMI 1.3	1	For monitoring display The monitoring image definition supports Smooth and High-Definition .
3D	1	1x 3D connector Connect the 3D emitter and use the compatible 3D glasses to enjoy a 3D visual experience. <p> Note</p> When the 3D function is enabled and the video source format is Side-by-Side or Top-and-Bottom , the device output capacity will be halved.
Audio Connectors		
AUDIO	2	1x AUDIO input, 1×AUDIO output <ul style="list-style-type: none"> 3.5 mm standard audio input and output connectors Audio sampling rate up to 48 kHz
Control Connectors		
ETHERNET	2	<ul style="list-style-type: none"> Connect to the control PC for device control and firmware upgrade via Unico. Status LEDs: <ul style="list-style-type: none"> The top left one indicates the connection status. <ul style="list-style-type: none"> On: The port is properly connected. Flashing: The port is not properly connected, such as loose connection. Off: The port is not connected. The top right one indicates the communication status. <ul style="list-style-type: none"> On: No data communication. Flashing: The communication is good and data is being transmitted. Off: No data transmission
USB	1	1x USB 2.0 <ul style="list-style-type: none"> Cascade the devices via the USB port and Ethernet port. Up to 5 devices can be cascaded. Update the firmware via the USB drive.

Connector	Qty	Description
		<ul style="list-style-type: none"> • Import or export device logs and EDID files.
RS232	1	3-pin connectors <ul style="list-style-type: none"> • RX: Receive signals. • TX: Send signals. • G: Ground
GENLOCK IN-LOOP	1	Connect to an external sync signal. Accepts bi-level and tri-level signals. <ul style="list-style-type: none"> • IN: Accept the sync signal. • LOOP: Loop the sync signal. • Genlock signal frame rate: 24 to 60Hz
LIGHT SENSOR	1	Connect to a light sensor to collect the ambient brightness, allowing for automatic screen brightness adjustment.

Applications

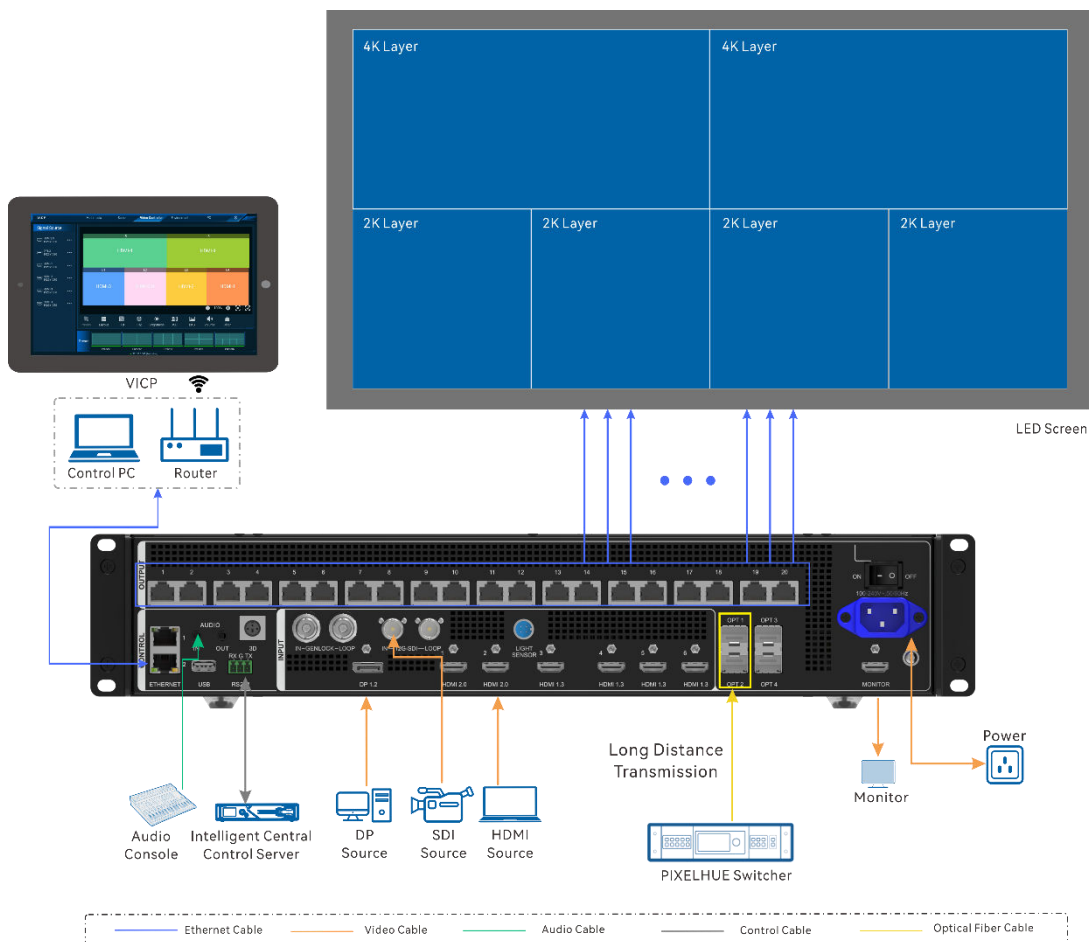

Dimensions

Device

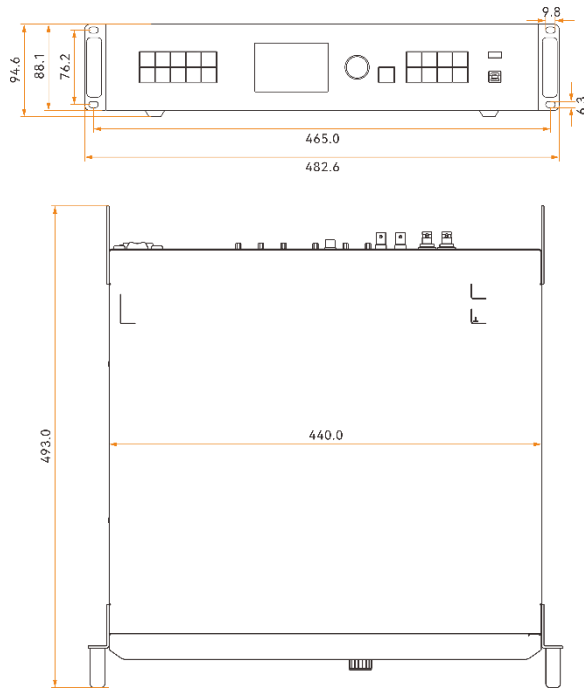

Tolerance: ± 0.5 Unit: mm

Flight Case

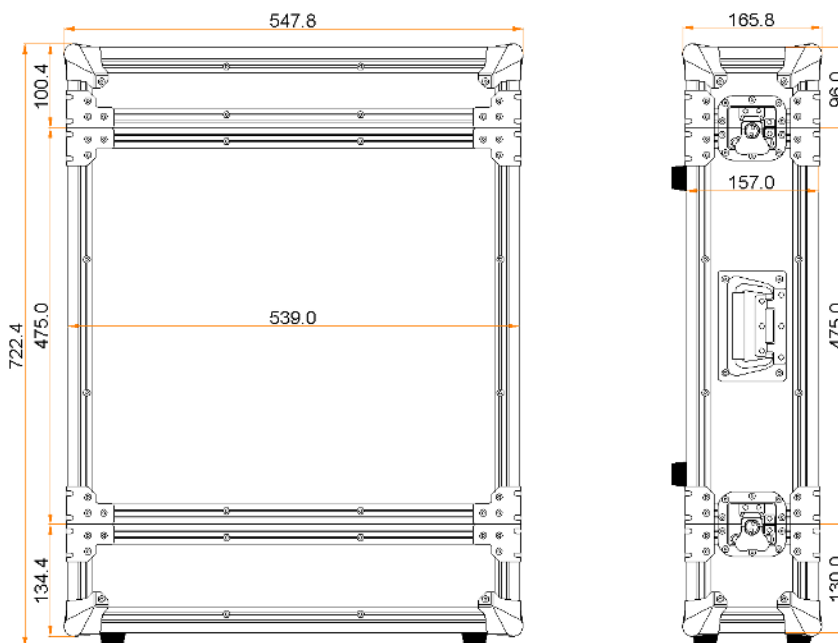

Tolerance: ± 5 Unit: mm

Note

If you require detailed dimensions and drawings of the flight case, please contact NovaStar customer service team.

Specifications

Electrical Parameters	Power connector	100-240V~, 50/60Hz, 2.5A-1.0A
	Rated power consumption	83 W
Operating Environment	Temperature	0°C to 50°C
	Humidity	5% RH to 85% RH, non-condensing
Storage Environment	Temperature	-10°C to +60°C
	Humidity	5% RH to 95% RH, non-condensing
Physical Specifications	Dimensions	482.6 mm × 493.0 mm × 94.6 mm
	Net weight	7.4 kg
	Total weight (packed with paper box)	11.2 kg
	Total weight (packed with flight case)	19.9 kg
Packing Information	Packing box	645 mm × 580 mm × 215 mm
	Flight case	722.4 mm × 547.8 mm × 165.8 mm
	Accessories	1x Power cord, 1x Ethernet cable, 1x HDMI cable, 4x Silicone dustproof plugs, 1x USB cable, 1x Phoenix connector, 1x Quick Start Guide, 1x Certificate of Approval, 1x Safety Manual
Accessories (optional)	1x Remote control	Note Please purchase the remote control as needed. (Item code: M07020005)
Noise Level (typical at 25°C/77°F)	45 dB (A)	

Video Source Features

Input Connectors	Common Resolutions		Color Space	Sampling Rate	Bit Depth	Integer Frame Rates (Hz)
HDMI 2.0	4K×2K	4096×2160	RGB / YCbCr	4:4:4	12bit	24/25/30
					10bit	24/25/30/48/50
					8bit	24/25/30/48/50/60
			YCbCr	4:2:2	8/10/12bit	
			YCbCr	4:2:0	8/10/12bit	
	4K×1K	3840×1080	RGB / YCbCr	4:4:4	12bit	24/25/30/48/50/60/72/85
					10bit	24/25/30/48/50/60/72/100
					8bit	24/25/30/48/50/60/72/120
			YCbCr	4:2:2	8/10/12bit	
			YCbCr	4:2:0	8/10/12bit	
	2K×1K	1920×1080	RGB / YCbCr	4:4:4	12bit	24/25/30/48/50/60/72/120/144
					10bit	24/25/30/48/50/60/72/120/144
					8bit	24/25/30/48/50/60/72/120/144
			YCbCr	4:2:2	8/10/12bit	
			YCbCr	4:2:0	8/10/12bit	
720P	1280×720	RGB / YCbCr	4:4:4	8bit	24/25/30/48/50/60/72/120/144/240	
DP 1.2	4K×2K	4096×2160	RGB / YCbCr	4:4:4	12bit	24/25/30
					10bit	24/25/30/48/50
					8bit	24/25/30/48/50/60
			YCbCr	4:2:2	8/10/12bit	
	4K×1K	3840×1080	RGB / YCbCr	4:4:4	12bit	24/25/30/48/50/60/72/85

Input Connectors	Common Resolutions		Color Space	Sampling Rate	Bit Depth	Integer Frame Rates (Hz)	
					10bit	24/25/30/48/50/60/72/100	
					8bit	24/25/30/48/50/60/72/120	
			YCbCr	4:2:2	8/10/12bit		
	2K×1K	1920×1080	RGB / YCbCr	4:4:4	12bit	24/25/30/48/50/60/72/120/144	
					10bit	24/25/30/48/50/60/72/120/144	
					8bit	24/25/30/48/50/60/72/120/144	
				YCbCr	4:2:2	8/10/12bit	
	720P	1280×720	RGB / YCbCr	4:4:4	8bit	24/25/30/48/50/60/72/120/144/240	
	HDMI 1.3	2K×1K	1920×1080	RGB / YCbCr	4:4:4	12bit	24/25/30
						10bit	24/25/30/48/50/60
8bit						24/25/30/48/50/60	
YCbCr				4:2:2	8/10/12bit		
/		800×600	RGB / YCbCr	4:4:4	8bit	24/25/30/48/50/60/72/120/144/240	
12G-SDI	4K×2K	4096×2160	YCbCr	4:2:2	8/10/12bit	24/25/30/48/50/60	
	4K×1K	3840×1080	YCbCr	4:2:2	8/10/12bit		
	2K×1K	1920×1080	YCbCr	4:2:2	8/10/12bit		

The table above shows some common resolutions and integer frame rates only. The adaptation to decimal frame rates is also supported, including 23.98/29.97/59.94/71.93/119.88Hz.

Notes and Cautions

Notes For Battery

- The battery is not intended to be replaced.

- Disposal of a battery into fire or a hot oven, or mechanically crushing or cutting of a battery can result in an explosion.
- Leaving a battery in an extremely high temperature surrounding environment can result in an explosion or the leakage of flammable liquid or gas.
- A battery subjected to extremely low air pressure may result in an explosion or the leakage of flammable liquid or gas.

Notes for Installation

When the product needs to be installed on the rack, 8 screws at least M5*8 should be used to fix it. The rack for installation shall bear at least 28kg weight.

- Elevated Operating Ambient - If installed in a closed or multi-unit rack assembly, the operating ambient temperature of the rack environment may be greater than room ambient. Therefore, consideration should be given to installing the equipment in an environment compatible with the maximum ambient temperature (T_{ma}) specified by the manufacturer.
- Reduced Air Flow - Installation of the equipment in a rack should be such that the amount of air flow required for safe operation of the equipment is not compromised.
- Mechanical Loading - Mounting of the equipment in the rack should be such that a hazardous condition is not achieved due to uneven mechanical loading.
- Circuit Overloading - Consideration should be given to the connection of the equipment to the supply circuit and the effect that overloading of the circuits might have on overcurrent protection and supply wiring. Appropriate consideration of equipment nameplate ratings should be used when addressing this concern.
- Reliable Earthing - Reliable earthing of rack-mounted equipment should be maintained. Particular attention should be given to supply connections other than direct connections to the branch circuit (e.g. use of power strips).

FCC Caution

- Any changes or modifications not expressly approved by the party responsible for compliance could void the user's authority to operate the equipment.
- This device complies with part 15 of the FCC Rules. Operation is subject to the following two conditions: (1) This device may not cause harmful interference, and (2) this device must accept any interference received, including interference that may cause undesired operation.
- Note: This equipment has been tested and found to comply with the limits for a Class A digital device, pursuant to part 15 of the FCC Rules. These limits are designed to provide

reasonable protection against harmful interference when the equipment is operated in a commercial environment. This equipment generates, uses, and can radiate radio frequency energy and, if not installed and used in accordance with the instruction manual, may cause harmful interference to radio communications. Operation of this equipment in a residential area is likely to cause harmful interference in which case the user will be required to correct the interference at his own expense.

Others

- Note: This product can only be placed horizontally. Do not mount vertically or upside-down.
- This is Class A product. In a domestic environment, this product may cause radio interference in which case the user may be required to take adequate measures.
- Please read the specifications thoroughly and use the product in accordance with the requirements. If you have any questions about the specifications, please contact us immediately. If you use the product improperly, not following the requirements, or for illegal purposes, you shall be solely responsible for any consequences arising therefrom.

Copyright

Copyright © 2026 Xi'an NovaStar Tech Co., Ltd. All Rights Reserved.

No part of this document may be copied, reproduced, extracted or transmitted in any form or by any means without the prior written consent of Xi'an NovaStar Tech Co., Ltd.

Trademark

 is a trademark of Xi'an NovaStar Tech Co., Ltd.

Statement

Thank you for choosing NovaStar's product. This document is intended to help you understand and use the product. For accuracy and reliability, NovaStar may make improvements and/or changes to this document at any time and without notice. If you experience any problems in use or have any suggestions, please contact us via the contact information given in this document. We will do our best to solve any issues, as well as evaluate and implement any suggestions.

| [Official website](http://www.novastar.tech)
| www.novastar.tech

| [Technical support](mailto:support@novastar.tech)
| support@novastar.tech